



VS PRODUCT NEWS

Lighting Component Systems

Content

RETAIL

EasyLine Simple Fix Mini Slim
EasyLine Simple Fix Mini Slim 100 V
EasyLine DIP switch C Mini
ComfortLine Dip Switch Mini Slim DALI2
EasyLine DIP switch C Gen.2
EasyLine DIP switch UT-155 GEN. 4
EasyLine DIP switch UT-200 120–277 V
ComfortLine Dip switch UT-212/250 DALI2
ComfortLine Dip switch C DALI2-Basic
ComfortLine DIP switch C DALI2-MemoryData
Blu2Light PrimeLine DIP switch C Casambi
PrimeLine NFC C DALI2 Dx
ComfortLine DIP switch C-wideUout DALI2
Comfort COB Gen. 3
Comfort COB Gen.2 - VCA2-122 and VCA2-123 and VCA2-124
Comfort COB Gen.2 -VCA2-1211 and VCA2-1213
LED Emergency Lighting Devices

OFFICE

EasyLine DIP switch L Gen.2
EasyLine DIP switch L 120V
ComfortLine DIP switch L-DALI2
PrimeLine NFC L DALI2 Dx
EasyLine DIP switch L-LV
EasyLine DIP switch L-LV DALI
Linear Optics 3R for SMD Comfort-B
LED Line SMD Comfort-B 3R Gen.2
Linear Grids 1R for SMD Light&Dark
Grids 2R for SMD Light&Dark 2Rx2 80mm
Linear Optics 1R for SMD Light&Dark
LED Line SMD W2.5 Light& Dark
LED SMD Light&Dark Square
Linear Optics 1R for SMD W2 Universal Tunnel Lens 560mm IP20/40
Linear Optics 1R for SMD W2- IP65
LED Line SMD W2 Comfort Gen. 2
LED Line SMD W2 Easy Gen. 2

STREET & INDUSTRY

EasyLine DIP switch S
ComfortLine NFC S MidNight
ComfortLine Prog S 1-10 V MidNight
PrimeLine NFC S-MD DALI2 Dx
ComfortLine Prog HP 1–10 V 12 V Aux IP
ComfortLine Prog S 100 V 1–10 V IP
ComfortLine Prog S-1-10V 100V IP 40W
EasyLine Poti S 100 V IP
EasyLine DIP switch S-100 V IP
LED Linear Allround 5050 Gen. 3
2x2 Streetlight Compact Optics for SMD W5 - 5050
Compact optics 2x6 for SMD W4.5 – 3535
SPD SP3/277/10K IP67 INLINE

CONSTANT VOLTAGE

EasyLine 12 V C-L Gen.2
EasyLine 24 V C-L Gen.2
EasyLine 24 V L-S
EasyLine 24 V IP Gen.2
EasyLine 24 V C-L 120V
ComfortLine 24 V L DALI2
ComfortLine 24V C DALI2 IP67

EasyLine Simple Fix Mini Slim

Cechy produktu

- Kompaktowy kształt obudowy

Parametry elektryczne

- Napięcie sieciowe: 220–240 V \pm 10%
- Częstotliwość sieci: 50–60 Hz
- Zaciski wtykowe
pierwotne: 0,75–1,5 mm²
wtórne: 0,5–1,5 mm²
- Współczynnik mocy przy pełnym obciążeniu: 0,9
- Maksymalne napięcie pracy bez obciążenia (U_{max.}): 60 V
- Przelączenie modułów LED po stronie wtórnej jest niedozwolone.



Parametry elektryczne

Max. wyjście W	Nazwa modelu	Numer katalogowy	Napięcie 50-60 Hz V	Prąd sieciowy mA	Prąd rozruchowy A / μ s	Prąd wyjściowy DC mA (\pm 10%)	Napięcie wyjściowe DC [V]	THD przy pełnym obciążeniu % (230 V)	Wydajność przy max.obciążeniu % (230 V)	Tętnienia 100 Hz %
7	ECXe 350.698	187494	220–240	43–40	7 / 95	350	8–20	10	77	< 5
7.8	ECXe 600.697	187493	220–240	46–43	8 / 103	600	6–13	10	79	< 5
8.4	ECXe 200.696	187492	220–240	49–45	7 / 121	200	30–42	10	83	< 5
9.1	ECXe 700.695	187491	220–240	54–49	7 / 89	700	6–13	9	79	< 5
10.5	ECXe 250.694	187490	220–240	60–55	8 / 135	250	30–42	8	83	< 5
10	ECXe 400.784	187670	220–240	55–51	6.7 / 206	400	2–25	11	85	< 5
13	ECXe 500.785	187671	220–240	55–62	6.7 / 206	500	2–25	10	85	< 5

Wymiary

- Obudowa: K108
- Długość: 100 mm
- Szerokość: 22 mm
- Wysokość: 21 mm

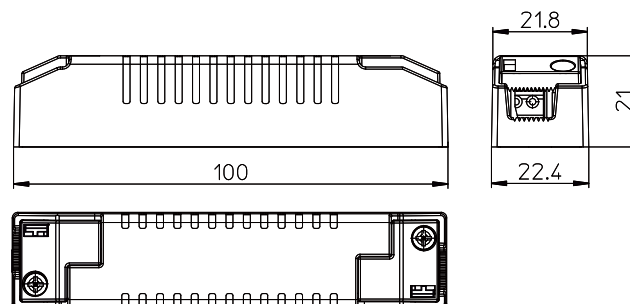

EasyLine Simple Fix Mini Slim 100 V

Cechy produktu

- Kompaktowy kształt obudowy
- Stały prąd wyjściowy

Parametry elektryczne

- Napięcie sieciowe: 110–240 V \pm 10%
- Częstotliwość sieci: 50–60 Hz
- Zaciski wtykowe: 0,5–1,5 mm²
- Współczynnik mocy przy pełnym obciążeniu: patrz tabela "parametry elektryczne"
- Maksymalne napięcie pracy bez obciążenia (U_{max.}): 60 V
- Przelączanie modułów LED po stronie wtórnej jest niedozwolone.



Parametry elektryczne

Max. wyjście W	Nazwa modelu	Numer katalogowy	Napięcie 50-60 Hz V	Prąd sieciowy mA	Prąd rozruchowy A / μ s	Prąd wyjściowy DC mA (\pm 10%)	Napięcie wyjściowe DC (V)	THD przy pełnym obciążeniu % (230 V)	Wydajność przy max. obciążeniu % (230 V)	Tętnienia 100 Hz %
9	ECXe 700.744	187601	100–240	98/45	14.4/198	700	6–13	15	87	<3
15	ECXe 350.745	187602	100–240	155/70	17.8/182	350	16–42	12	88	<3
21	ECXe 500.746	187603	100–240	225/100	21.4/218	500	16–42	12	88	<3
5	ECXe 350.747	187604	100–240	51/25	12.6/174	350	6–13	12	83	<3

Wymiary

Numer katalogowy	Typ obudowy	Długość a (mm)	Szerokość b (mm)	Wysokość c (mm)
------------------	-------------	----------------	------------------	-----------------

EasyLine Simple Fix Mini Slim 100 V

wszystkie	K120	127	27.4	21
-----------	------	-----	------	----

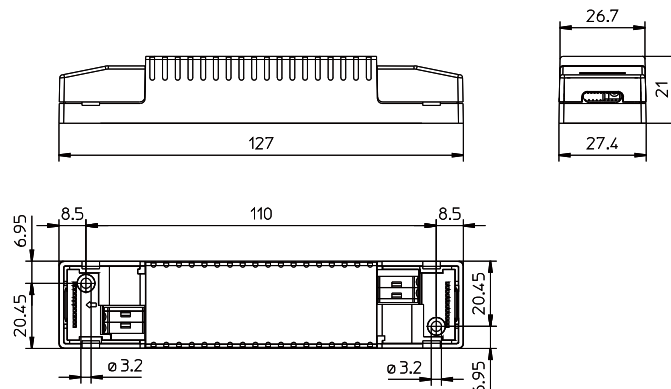

EasyLine DIP switch C Mini

Cechy produktu

- Bardzo kompaktowy kształt obudowy (Mini)

Funkcje

- Prąd wyjściowy regulowany za pomocą przełącznika DIP

Parametry elektryczne

- Napięcie sieciowe: 110–240 V \pm 10%
- Częstotliwość sieci: 50–60 Hz
- Zaciski wtykowe
druć: 0,5–1,5 mm²
linka: 0,75–1,5 mm²
- Współczynnik mocy przy pełnym obciążeniu: >0.90
- Maksymalne napięcie pracy bez obciążenia (U_{max.}): 60 V
- Przełączanie modułów LED po stronie wtórnej jest niedozwolone.



Parametry elektryczne

Max. wyjście W	Nazwa modelu	Numer katalogowy	Napięcie 50-60 Hz V	Prąd sieciowy mA	Prąd rozruchowy A / μ s	Prąd wyjściowy DC mA (\pm 5%; for 14W \pm 7,5%)	Napięcie wyjściowe DC (V)	THD przy pełnym obciążeniu % (230 V)	Wydajność przy max. obciążeniu % (230 V)	Temperatura 100 Hz %
4.5	ECXe 225.734	187574	220–240	28–23	12.1 / 162	150/175/200/225	6-20	< 10	81	< 3
8	ECXe 400.735	187575	220–240	50–37	11.1 / 158	250/300/350/400	6-20	< 10	82	< 3
9.5	ECXe 225.736	187576	220–240	65–45	11.6 / 160	150/175/200/225	20-42	< 10	85	< 3
17	ECXe 400.737	187577	220–240	90–75	14.2 / 166	250/300/350/400	20-42	< 10	87	< 3

Wymiary

Numer katalogowy	Typ obudowy	Długość a (mm)	Szerokość b (mm)	Wysokość c (mm)
187574, 187575, 187576, 187577	K115	70	43	20

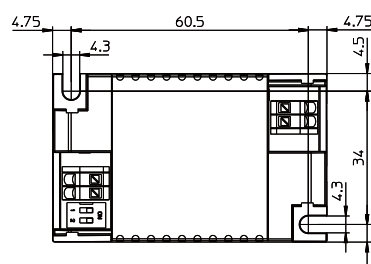
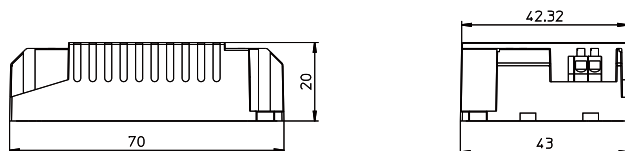

ComfortLine Dip Switch Mini Slim DALI2

Cechy produktu

- Kompaktowy kształt obudowy

Parametry elektryczne

- Napięcie sieciowe: 220–240 V \pm 10%
- Częstotliwość sieci: 50–60 Hz
- Zaciski wtykowe
 pierwotne: 0,75–1,5 mm²
 wtórne: 0,5–1,5 mm²
- Współczynnik mocy przy pełnym obciążeniu: 0,9
- Maksymalne napięcie pracy bez obciążenia (U_{max.}): 60 V
- Przelączenie modułów LED po stronie wtórnej jest niedozwolone.

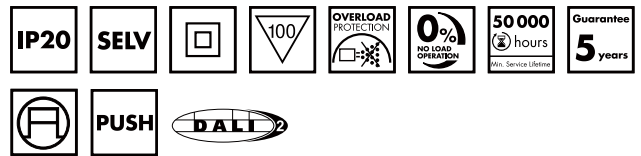

Parametry elektryczne

Max. wyjście W	Nazwa modelu	Numer katalogowy	Napięcie 50-60 Hz V	Prąd sieciowy mA	Prąd rozruchowy A / μ s	Prąd wyjściowy DC mA (\pm 10%)	Napięcie wyjściowe DC (V)	THD przy pełnym obciążeniu % (230 V)	Wydajność przy max. obciążeniu % (230 V)	Tętnienia 100 Hz %
9.1	ECXd 700.700	187496	220–240	53–49	7 / 196	350/500/600/700	6–13	7	81	< 5
10.5	ECXd 250.699	187495	220–240	57–53	7 / 198	100/150/200/250	30–42	7	87	< 5

Wymiary

- Obudowa: K109
- Długość: 110 mm
- Szerokość: 27.4 mm
- Wysokość: 21 mm

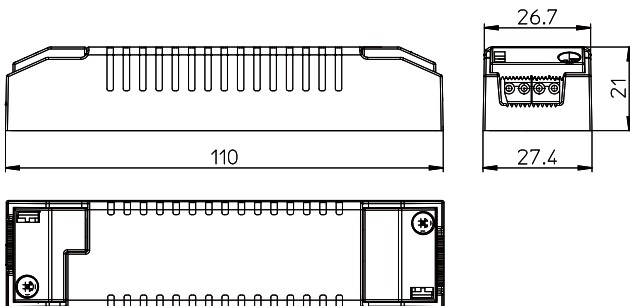

EasyLine DIP switch C Gen.2

Cechy produktu

- Kompaktowy kształt obudowy

Funkcje

- Prąd wyjściowy regulowany za pomocą przełącznika DIP

Parametry elektryczne

- Napięcie sieciowe: 220–240 V \pm 10%
- Częstotliwość sieci: 50–60 Hz
- Zaczepki wtykowe
drut: 0,5–1,5 mm²
linka: 0,75–1,5 mm²
- Współczynnik mocy przy pełnym obciążeniu: >0.95
- Maksymalne napięcie pracy bez obciążenia (U_{max.}): 60 V
- Przelączanie modułów LED po stronie wtórnej jest niedozwolone.



Parametry elektryczne

Max. wyjście W	Nazwa modelu	Numer katalogowy	Napięcie 50-60 Hz V	Prąd sieciowy mA	Prąd rozruchowy A / μ s	Prąd wyjściowy DC mA (\pm 5%; for 14W \pm 7,5%)	Napięcie wyjściowe DC (V)	THD przy pełnym obciążeniu % (230 V)	Wydajność przy max. obciążeniu % (230 V)	Tętnienia 100 Hz %
14	ECXe 700.666	187419	220–240	80-65	15 / 244	350/500/550/700	6-20	14	83	<5
17	ECXe 400.667	187420	220–240	95-80	15 / 246	250/300/350/400	20-42	14	87	<5
25	ECXe 600.668	187421	220–240	140-120	15 / 250	450/500/550/600	20-42	9	88	<5
33	ECXe 800.669	187422	220–240	180-160	20 / 266	650/700/750/800	20-42	8	89	<5
40	ECXe 800.670	187423	220-240	215-180	23 / 260	500/600/700/800	30-50	8	89	<5
44	ECXe 1050.671	187424	220-240	240-210	18 / 275	900/950/1000/1050	20-42	9	89	<5
59	ECXe 1400.692	187474	220-240	300-250	29 / 300	1100/1200/1300/1400	20-42	15	92	<5

Wymiary

Numer katalogowy	Typ obudowy	Długość a (mm)	Szerokość b (mm)	Wysokość c (mm)
187419, 187420, 187421, 187422, 187423, 187424	K107	97	43	23
187474	K110	117	42	23

K107

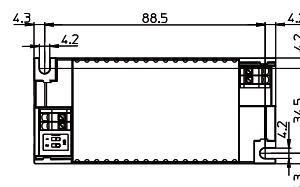
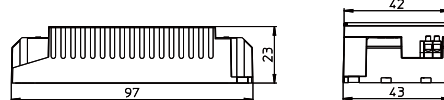

K110

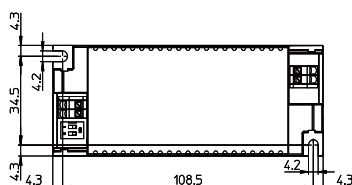
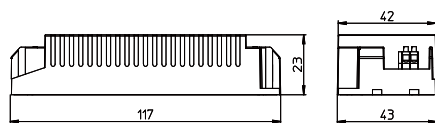

EasyLine DIP switch UT-155 GEN. 4

Cechy produktu

- Adapter ze zintegrowaną elektroniką sterownika LED do popularnych systemów szynowych 3-fazowych
- Dostępne w trzech różnych kolorach obudowy: białym (RAL 9003), czarnym (RAL 9005) i szarym (RAL 7040)

Funkcje

- Prąd wyjściowy regulowany za pomocą przełącznika DIP
- Prąd wyjściowy można swobodnie regulować w zakresie od 450 mA do 1050 mA

Parametry elektryczne

- Napięcie sieciowe: 220–240 V \pm 10%
- Częstotliwość sieci: 50–60 Hz
- Współczynnik mocy przy pełnym obciążeniu: >0.95
- Maksymalne napięcie pracy bez obciążenia (U_{max.}): 55 V
- Przelączanie modułów LED po stronie wtórnej jest niedozwolone.
- SVM: < 0.4
- PstLM: < 1



Parametry elektryczne

Max. wyjście W	Nazwa modelu	Numer katalogowy	Kolor obudowy	Napięcie 50-60 Hz V	Prąd sieciowy mA	Prąd rozruchowy A / μ s	Prąd wyjściowy DC mA (\pm 5%)	Napięcie wyjściowe DC (V)	THD przy pełnym obciążeniu % (230 V)	Wydajność przy max. obciążeniu % (230 V)	Tętnienia 100 Hz %
25	ECXe 600.718	187535	biała (RAL 9003)	220–240	126–115	19 / 118	450/500/ 550/600	24–42	4	92	5
		187536	czarna (RAL 9005)								
		187537	szara (RAL 7040)								
34	ECXe 800.719	187538	biała (RAL 9003)	220–240	171–155	21 / 134	650/700/ 750/800	24–42	5	92	5
		187539	czarna (RAL 9005)								
		187540	szara (RAL 7040)								
42	ECXe 1050.720	187541	biała (RAL 9003)	220–240	213–192	22 / 144	900/950/ 1000/1050	24–42	5	91	5
		187542	czarna (RAL 9005)					24–40			
		187543	szara (RAL 7040)					24–40 (@1050mA)			

Wymiary

Numer katalogowy	Typ obudowy	Długość a (mm)	Szerokość b (mm)	Wysokość c (mm)
wszystkie	UT-155	155	31,1	42,2 14,1

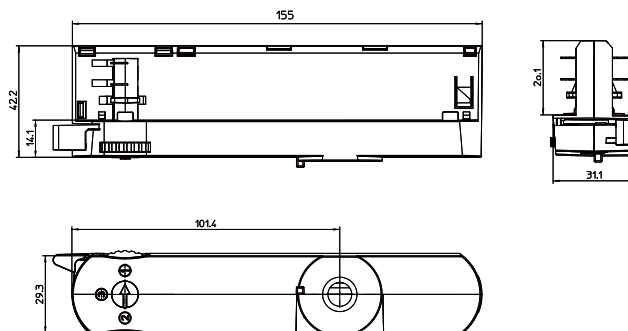

EasyLine DIP switch UT-200 120-277 V

Cechy produktu

- Adapter ze zintegrowaną elektroniką sterownika LED do popularnych systemów szynowych 3-fazowych
- Dostępne w trzech różnych kolorach obudowy: białym (RAL 9003), czarnym (RAL 9005) i szarym (RAL 7040)

Funkcje

- Prąd wyjściowy regulowany za pomocą przełącznika DIP
- Prąd wyjściowy można swobodnie regulować w zakresie od 200 mA do 1050 mA

Parametry elektryczne

- Napięcie sieciowe: 120-240 V \pm 10%
- Częstotliwość sieci: 50-60 Hz
- Współczynnik mocy przy pełnym obciążeniu: $>$ 0.95
- Maksymalne napięcie pracy bez obciążenia (U_{max.}): 60 V
- Przelączanie modułów LED po stronie wtórnej jest niedozwolone.
- SVM: $<$ 0.4
- PstLM: $<$ 1



Parametry elektryczne

Max. wyjście W	Nazwa modelu	Numer katalogowy	Kolor obudowy	Napięcie 50-60 Hz V	Prąd sieciowy mA	Prąd rozruchowy A / μ s	Prąd wyjściowy DC mA (\pm 5%)	Napięcie wyjściowe DC (V)	THD przy pełnym obciążeniu % (230 V)	Wydajność przy max. obciążeniu % (230 V)	Łętnienia 100 Hz %
42	ECXe 1050.656	187396	biała (RAL 9003)	120-277	413-178	17 / 172	200-1050	zobacz tabele ustawienie DIP	4	85	5
		187397	czarna (RAL 9005)								
		187398	szara (RAL 7040)								

Wymiary

Numer katalogowy	Typ obudowy	Długość a (mm)	Szerokość b (mm)	Wysokość c (mm)
ECXe 1050.656	UT-200	200	30.6	41.6 13.6

T-200

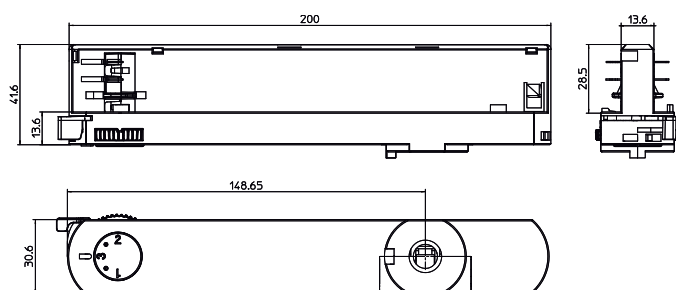

ECXe 1050.656								
Pin					Moc W	Prąd mA	Napięcie V	Ustawienia fabryczne (mA)
1	2	3	4					
OFF	OFF	OFF	OFF	8.4	200	24-42	1050	
ON	OFF	OFF	OFF	10.5	250			
OFF	ON	OFF	OFF	12.6	300			
ON	ON	OFF	OFF	14.7	350			
OFF	OFF	ON	OFF	16.8	400			
ON	OFF	ON	OFF	21.0	500			
OFF	ON	ON	OFF	23.1	550			
ON	ON	ON	OFF	25.2	600			
OFF	OFF	OFF	ON	27.3	650			
ON	OFF	OFF	ON	29.4	700			
OFF	ON	OFF	ON	33.6	800			
ON	ON	OFF	ON	35.7	850			
OFF	OFF	ON	ON	37.8	900			
ON	OFF	ON	ON	39.9	950			
OFF	ON	ON	ON	42.0	1000			
ON	ON	ON	ON	42.0	1050			24-40

ComfortLine Dip switch UT-212/250 DALI2

Cechy produktu

- Adapter ze zintegrowaną elektroniką sterownika LED do systemów szynowych zgodnych ze standardem DALI
- Dostępne w trzech różnych kolorach obudowy: białym, czarnym i szarym

Funkcje

- Prąd wyjściowy regulowany za pomocą przełącznika DIP
- Prąd wyjściowy można swobodnie regulować w zakresie od 120 mA do 1050 mA (w zależności od typu)

Parametry elektryczne

- Napięcie sieciowe: 220–240 V \pm 10%
- Częstotliwość sieci: 50–60 Hz
- Współczynnik mocy przy pełnym obciążeniu: $>$ 0.95
- Maksymalne napięcie pracy bez obciążenia (U_{max.}): 60 V
- Przełączanie modułów LED po stronie wtórnej jest niedozwolone.
- SVM: $<$ 0.4
- PstLM: $<$ 1



Parametry elektryczne

Max. wyjście W	Nazwa modelu	Numer katalogowy	Kolor obudowy	Napięcie 50-60 Hz V	Prąd sieciowy mA	Prąd rozruchowy A / μ s	Prąd wyjściowy DC mA (\pm 5%)	Napięcie wyjściowe DC (V)	THD przy pełnym obciążeniu % (230 V)	Wydajność przy max. obciążeniu % (230 V)	Tętnienia 100 Hz %
15	ECXd 350.647	187369	biała	220–240	84–790	10 / 80	120–350	9–42	8	83	1
		187370	czarna								
		187371	szara								
29	ECXd 700.648	187372	biała	220–240	161–149	18 / 104	350–700	9–42	9	85	1
		187373	czarna								
		187374	szara								
40	ECXd 1050.649	187375	biała	220–240	208–191	15 / 100	700–1050	9–42 (38.5 V)	9	86	1
		187376	czarna								
		187377	szara								

Wymiary

Numer katalogowy	Typ obudowy	Długość a (mm)	Szerokość b (mm)	Wysokość c (mm)
ECXd 350.647	UT-212	211.8	30.6	44.5 13.6
ECXd 700.648	UT-250	247.8	30.6	45.5 13.6
ECXd 1050.649	UT-250	247.8	30.6	45.5 13.6

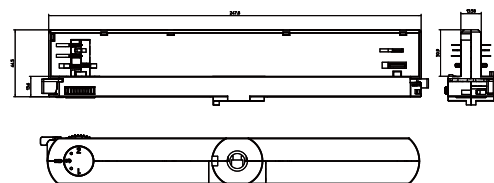
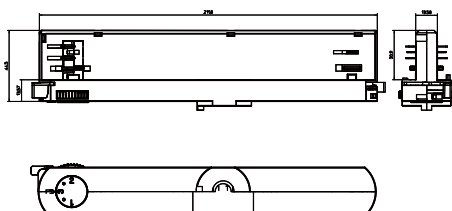

ComfortLine Dip switch C DALI2-Basic

Cechy produktu

- Kompaktowy kształt obudowy

Funkcje

- Prąd wyjściowy regulowany za pomocą przełącznika DIP

Parametry elektryczne

- Napięcie sieciowe: 220–240 V \pm 10%
- Częstotliwość sieci: 50–60 Hz
- Zaciski wykłowe
druć: 0,5–1,5 mm²
linka: 0,75–1,5 mm²
- Współczynnik mocy przy pełnym obciążeniu: >0.95
- Maksymalne napięcie pracy bez obciążenia (U_{max.}): 60 V
- Przelączanie modułów LED po stronie wtórnej jest niedozwolone.

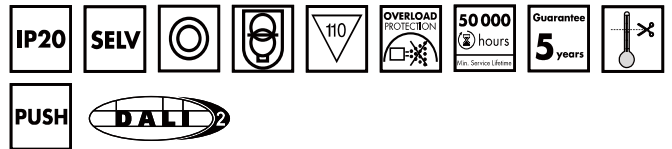

Parametry elektryczne

Max. wyjście W	Nazwa modelu	Numer katalogowy	Napięcie 50-60 Hz V	Prąd sieciowy mA	Prąd rozruchowy A / μ s	Prąd wyjściowy DC mA (\pm 5%; for 14W \pm 7,5%)	Napięcie wyjściowe DC (V)	THD przy pełnym obciążeniu % (230 V)	Wydajność przy max. obciążeniu % (230 V)	Tętnienia 100 Hz %
14	ECXd 700.674	187439	220–240	86–65	14/254	350/500/550/700	6-20	15	84	<5
17	ECXd 400.675	187440	220–240	100–75	15/234	250/300/350/400	20-42	13	87	<5
25	ECXd 600.676	187441	220–240	140–110	16/238	450/500/550/600	20-42	15	89	<5
33	ECXd 800.677	187442	220–240	185–165	24/240	650/700/750/800	20-42	11	89	<5
40	ECXd 800.693	187475	220–240	215–180	24/240	500/600/700/800	30-50	11	89	<5
44	ECXd 1050.678	187443	220–240	240–200	24/240	900/950/1000/1050	20-42	10	89	<5

Wymiary

Numer katalogowy	Typ obudowy	Długość a (mm)	Szerokość b (mm)	Wysokość c (mm)
wszystkie	K107	97	43	23

K107

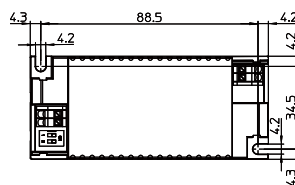
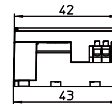

ComfortLine DIP switch C DALI2-MemoryData

Cechy produktu

- Kompaktowy kształt obudowy

Funkcje

- Prąd wyjściowy regulowany za pomocą przełącznika DIP
- Nadaje się do systemu baterii centralnej do oświetlenia awaryjnego zgodnie z normą EN 50172

Parametry elektryczne

- Napięcie sieciowe: 220–240 V $\pm 10\%$
- Częstotliwość sieci: 50–60 Hz
- Praca DC: 176–276 V (zakres pracy)
- Zaciski wtykowe
drut: 0,5–1,5 mm²
linka: 0,75–1,5 mm²
- Współczynnik mocy przy pełnym obciążeniu: >0.95
- Maksymalne napięcie pracy bez obciążenia (U_{max}): 60 V
- Przełączanie modułów LED po stronie wtórnej jest niedozwolone.
- ŚCIEMNIACZ: DALI (ED.2) DANE PAMIĘCI Specyfikacja (PARTS 251/252/253)

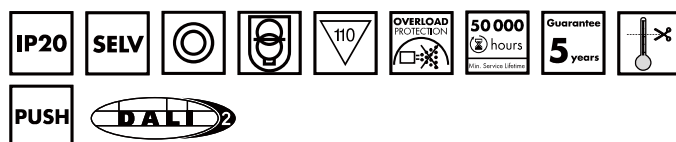

Parametry elektryczne

Max. wyjście W	Nazwa modelu	Numer katalogowy	Napięcie 50-60 Hz V	Prąd sieciowy mA	Prąd rozruchowy A / μ s	Prąd wyjściowy DC mA ($\pm 5\%$; for 14W $\pm 7.5\%$)	Napięcie wyjściowe DC (V)	THD przy pełnym obciążeniu % (230 V)	Wydajność przy max. obciążeniu % (230 V)	Temperatura 100 Hz %
30	ECXd 700.679	187444	220–240	165–125	9/39	350-700	9-42	5	89	<5
44	ECXd 1050.680	187445	220–240	245–190	11/52	700-1050	9-42	5	89	<5

Wymiary

Numer katalogowy	Typ obudowy	Długość a (mm)	Szerokość b (mm)	Wysokość c (mm)
wszystkie	K107	97	43	23

K107

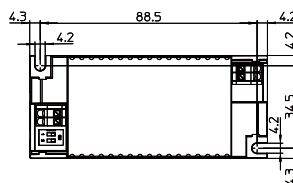
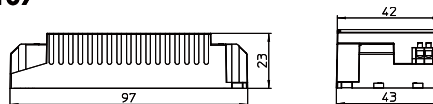

PrimeLine NFC C DALI2 Dx

Cechy produktu

- Kompaktowy kształt obudowy

Funkcje

- Programowalny przez interfejs NFC (bezdotykowo)
 - Wybieralny prąd wyjściowy
 - Programowalna funkcja CLO
 - Regulowany poziom DC
- Z wbudowanym, przełączanym zasilaczem DALI
- Możliwość ściemniania: Specyfikacja DALI (ED.2) D4i (części 250/251/252/253)

Parametry elektryczne

- Napięcie sieciowe: 220–240 V $\pm 10\%$
- Częstotliwość sieci: 50–60 Hz
- Praca DC: 176–276 V (zakres pracy)
- Zaciski wyłkowe
 - druk: 0,5–1,5 mm²
 - linka: 0,75–1,5 mm²
- Współczynnik mocy przy pełnym obciążeniu: >0.95
- Maksymalne napięcie pracy bez obciążenia (U_{max.}): 60 V
- Przełączanie modułów LED po stronie wtórnej jest niedozwolone.



Parametry elektryczne

Max. wyjście W	Nazwa modelu	Numer katalogowy	Napięcie V	Prąd sieciowy mA	Prąd rozruchowy A / μ s	Prąd DC mA ($\pm 8\%$ 150-350mA $\pm 5\%$ 350-1050mA)	Napięcie wyjściowe DC [V]	THD przy pełnym obciążeniu % (230 V)	Wydajność przy max. obciążeniu % (230 V)	Tętnienia 100 Hz %
44	ECXd 1050.681	187446	220–240	260–200	17/198	150-1050	9-50 (patrz obszar roboczy)	4	88	<5

Wymiary

Numer katalogowy	Typ obudowy	Długość a (mm)	Szerokość b (mm)	Wysokość c (mm)
187446	K110	117	42	23

K110

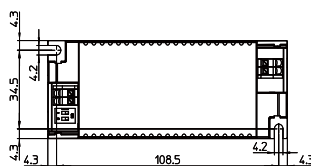
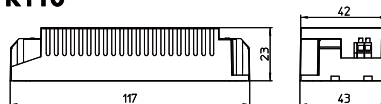

Cord grip "sl" for K107 / K110

Blu2Light PrimeLine DIP switch C Casambi

Cechy produktu

- Kompaktowy kształt obudowy

Funkcje

- Wybór prądu wyjściowego za pomocą przełącznika DIP
- Technologia Blu2Light Casambi
- Nadaje się do centralnego systemu zasilania akumulatorowego do oświetlenia awaryjnego zgodnie z normą EN 50172

Parametry elektryczne

- Napięcie sieciowe: 220–240 V \pm 10%
- Częstotliwość sieci: 50–60 Hz
- Praca DC: 176-276 V (zakres pracy)
- Zaciski wtykowe
drut: 0,5–1,5 mm²
linka: 0,75–1,5 mm²
- Współczynnik mocy przy pełnym obciążeniu: >0.95
- Maksymalne napięcie pracy bez obciążenia (U_{max.}): 60 V
- Przełączanie modułów LED po stronie wtórnej jest niedozwolone.



CASAMBI Blu2Light

Parametry elektryczne

Max. wyjście W	Nazwa modelu	Numer katalogowy	Napięcie 50-60 Hz V	Prąd sieciowy mA	Prąd rozruchowy A / μ s	Prąd wyjściowy DC mA (\pm 5%)	Napięcie wyjściowe DC (V)	THD przy pełnym obciążeniu % (230 V)	Wydajność przy max. obciążeniu % (230 V)	Tętnienia 100 Hz %
42	ECXd 1050.758	187627	220–240	214–198	10 / 32	150–1050	9–50	< 5	91,5	< 3

Wymiary

Numer katalogowy	Typ obudowy	Długość a (mm)	Szerokość b (mm)	Wysokość c (mm)
187627	K86.1	97	43	30

K86

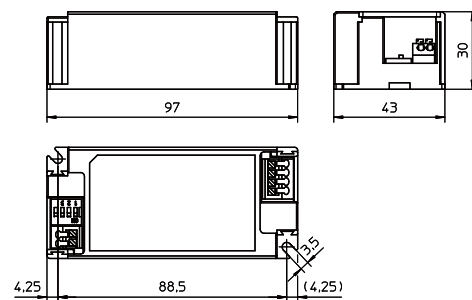

Charakterystyka optyki

at_p = 65 °C

e ² 2 qcp	Numer kat.	b μ	α ^c c ² 2 Ø 2 6	p										b	S	ZS	T[k]	b q e c9	
				350 mA		500 mA		600 mA		700 mA		1050 mA							
				lm	lm/W	lm	lm/W	lm	lm/W	lm	lm/W	lm	lm/W					k ²	δ
VCA3-126 - CRI 80																			
VCA3-126-827	573408	warm white	2700	2102	181	2912	170	3408	164	3917	139	—	—	120	82	827/369			
VCA3-126-830	573409	warm white	3000	2213	190	3065	179	3587	172	4123	167	—	—	120	82	830/369			
VCA3-126-830B	573410	warm white	3000 (below BBL)	2168	187	3004	175	3516	169	4040	163	—	—	120	82	830/369			
VCA3-126-831PW	573411	pearl white	3100	2213	190	3065	179	3587	172	4123	167	—	—	120	82	831/369			
VCA3-126-832CW	573412	clear white	3200	2217	191	3071	179	3594	173	4131	167	—	—	120	82	832/369			
VCA3-126-835	573413	neutral white	3500	2235	192	3096	181	3623	174	4164	169	—	—	120	82	835/369			
VCA3-126-840	573414	neutral white	4000	2279	196	3156	184	3694	177	4244	172	—	—	120	82	840/369			
VCA3-126-850	573415	cool white	5000	2323	200	3218	188	3766	181	4328	175	—	—	120	82	850/369			
VCA3-126-857	573416	cool white	5700	2301	198	3187	186	3730	179	4287	173	—	—	120	82	857/369			
VCA3-126 - CRI 90																			
VCA3-126-927	573417	warm white	2700	1732	149	2399	140	2808	135	3228	131	—	—	120	92	927/369			
VCA3-126-930	573418	warm white	3000 (below BBL)	1845	159	2556	149	2992	144	3438	139	—	—	120	92	930/369			
VCA3-126-931PW	573419	pearl white	3100	1809	156	2505	146	2931	141	3369	136	—	—	120	92	931/369			
VCA3-126-932CW	573420	clear white	3200	1818	156	2505	146	2931	141	3385	137	—	—	120	92	932/369			
VCA3-126-935	573421	neutral white	3500 (below BBL)	1864	160	2582	151	3020	145	3472	141	—	—	120	92	935/369			
VCA3-126-940	573422	neutral white	4000 (below BBL)	1900	164	2632	153	3081	148	3541	143	—	—	120	92	940/369			
VCA3-128 - CRI 80																			
VCA3-128-827	573423	warm white	2700	2129	186	2979	178	3526	174	4068	170	3812	156	120	82	827/369			
VCA3-128-830	573424	warm white	3000	2241	196	3136	188	3713	184	4282	179	6116	164	120	82	830/369			
VCA3-128-830B	573425	warm white	3000 (below BBL)	2196	192	3073	184	3637	180	4196	175	5993	161	120	82	830/369			
VCA3-128-831PW	573426	pearl white	3100	2241	196	3136	188	3713	184	4282	179	6116	164	120	82	831/369			
VCA3-128-832CW	573427	clear white	3200	2246	196	3142	188	3720	184	4290	179	6128	164	120	82	832/369			
VCA3-128-835	573428	neutral white	3500	2263	198	3167	190	3750	185	4325	181	6177	166	120	82	835/369			
VCA3-128-840	573429	neutral white	4000	2308	202	3229	193	3822	189	4409	184	6297	169	120	82	840/369			
VCA3-128-850	573430	cool white	5000	2353	206	3292	197	3897	193	4495	188	6421	172	120	82	850/369			
VCA3-128-857	573431	cool white	5700	2330	204	3260	195	3839	191	4432	186	6360	171	120	82	857/369			
VCA3-128 - CRI 90																			
VCA3-128-927	573432	warm white	2700	1754	153	2455	147	2906	144	3352	140	4780	128	120	92	927/369			
VCA3-128-930	573433	warm white	3000 (below BBL)	1809	163	2615	157	3096	153	3571	149	5101	137	120	92	930/369			
VCA3-128-930W	573434	warm white	3000 (wid)	1608	140	2271	136	2713	134	3108	130	4513	121	120	96	930/369			
VCA3-128-931PW	573435	pearl white	3100	1832	160	2563	153	3035	150	3500	146	4999	134	120	92	931/369			
VCA3-128-932CW	573436	clear white	3200	1840	161	2575	154	3049	151	3516	147	5022	135	120	92	932/369			
VCA3-128-935	573437	neutral white	3500 (below BBL)	1887	165	2641	158	3126	155	3606	151	5151	138	120	92	935/369			
VCA3-128-940	573438	neutral white	4000 (below BBL)	1924	168	2693	161	3190	158	3677	154	5252	141	120	92	940/369			
VCA3-128-950	573439	cool white	5000	2018	179	2824	169	3343	165	3855	161	5507	148	120	92	950/369			
VCA3-128 - FOOD																			
VCA3-128-MP	573440	Meat "Pink"	2000 "pink effect"	1320	115	1847	111	2186	108	2522	105	3602	97	120	82	820/369			
VCA3-128-MV	573441	Meat "Vivid"	3100 "meat vivid"	1376	120	1937	116	2306	114	2658	111	3861	104	120	88	831/369			
VCA3-128-VBread	573442	VBread	2500 "VBread"	1763	154	2482	149	2957	146	3401	142	4640	133	120	88	825/369			

6 p μ c² 68 Ø J A d² 6R q² 66 p μ c² 68 q z6 s² S S S μ ct S q² 68 =<0 d S: T[k] k² NF < F 8NI < I 8NI B I A < S

Charakterystyka optyki

at $t_p = 65^\circ\text{C}$

e ² 2 qđμ	Numer katalogowy	b μ	p ^c c ² 2	p Ś μ 66 Ś q ² ś						b Ś zŚ	T kJ	b q
				∅ 2 6	250 mA		350 mA		500 mA			
			b	lm	lm/W	lm	lm/W	lm	lm/W		k ²	ę c ó

VCA2-122 - CRI 80

VCA2-123-827	571339	warm white	2700	1350	157	1809	147	2447	134	120	82	827/369
VCA2-123-830	571341	warm white	3000	1420	165	1904	155	2575	141	120	82	830/369
VCA2-123-840	571343	neutral white	4000	1462	170	1961	159	2652	146	120	82	840/369
VCA2-123-857	571344	cool white	5700	1477	172	1980	161	2678	147	120	82	857/369

VCA2-123 - CRI 90

VCA2-123-927	571346	warm white	2700	1107	129	1483	121	2006	110	120	92	927/369
VCA2-123-930	571348	warm white	3000 (below BBL)	1178	137	1580	128	2138	117	120	92	930/369
VCA2-123-935	571349	neutral white	3500 (below BBL)	1190	138	1595	130	2157	118	120	92	935/369
VCA2-123-940	571351	neutral white	4000 (below BBL)	1214	141	1627	132	2201	121	120	92	940/369

ó p μ² óś ∅ J A d² óR q² óó p μ² óś q zó ś² Ś Ś Ś μ c t Ś q² ś óś = <0 d Ś: T kJ k² J NF < F 8NI < I

e ² 2 qđμ	Numer katalogowy	b μ	p ^c c ² 2	p Ś μ 66 Ś q ² ś						b Ś zŚ	T kJ	b q
				∅ 2 6	350 mA		500 mA		700 mA			
			b	lm	lm/W	lm	lm/W	lm	lm/W		k ²	ę c ó

VCA2-124 - CRI 80

VCA2-124-827	572176	warm white	2700	1770	149	2399	136	3113	121	120	82	827/369
VCA2-124-830	572177	warm white	3000	1862	156	2524	143	3275	127	120	82	830/369
VCA2-124-830B	572178	warm white	3000 (below BBL)	1826	153	2474	140	3211	125	120	82	830/369
VCA2-124-840	572179	neutral white	4000	1918	161	2599	147	3373	131	120	82	840/369

VCA2-124 - CRI 90

VCA2-124-927	572180	warm white	2700	1452	122	1967	112	2553	99	120	92	927/369
VCA2-124-930	572181	warm white	3000 (below BBL)	1546	130	2095	119	2719	106	120	92	930/369
VCA2-124-935	572182	neutral white	3500 (below BBL)	1561	131	2116	120	2746	107	120	92	935/369
VCA2-124-940	572183	neutral white	4000 (below BBL)	1592	134	2157	122	2800	109	120	92	940/369

ó p μ² óś ∅ J A d² óR q² óó p μ² óś q zó ś² Ś Ś Ś μ c t Ś q² ś óś = <0 d Ś: T kJ k² J NF < F 8NI < I

Wymiary

VCA2-122

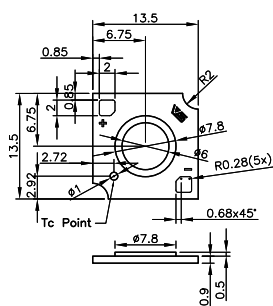

VCA2-123 / 124

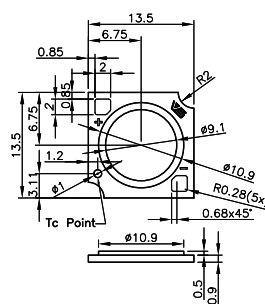

Charakterystyka optyki

at $t_p = 65^\circ\text{C}$

e ² q _{cp}	Numer kat.	b μ	ϕ ² 2 2 2 6	p										b	T _{kj}	b q	
				700 mA	1050 mA		1400 mA		1700 mA		2100 mA		z				9
				lm	lm/W	lm	lm/W	lm	lm/W	lm	lm/W	lm	lm/W	lm	lm/W	k ²	ó

VCA2-1213 - CRI 80

VCA2-1213-827	571428	warm white	2700	4054	176	5848	164	7519	155	8827	147	10449	137	120	82	827/369
VCA2-1213-830	571429	warm white	3000	4266	185	6155	173	7913	163	9291	154	10998	144	120	82	830/369
VCA2-1213-830B	571430	warm white	3000 (below BBL)	4181	181	6032	170	7755	160	9105	151	10777	141	120	82	830/369
VCA2-1213-831PW	571431	pearl white	3100	4266	185	6155	173	7913	163	9291	154	10998	144	120	82	831/369
VCA2-1213-832CW	571432	clear white	3200	4275	185	6167	173	7929	163	9310	155	11020	144	120	82	832/369
VCA2-1213-835	571433	neutral white	3500	4310	187	6217	175	7993	164	9384	156	11108	146	120	82	835/369
VCA2-1213-840	571434	neutral white	4000	4394	191	6338	178	8148	168	9567	159	11324	148	120	82	840/369
VCA2-1213-850	571435	cool white	5000	4480	194	6462	182	8308	171	9754	162	11546	151	120	82	850/369
VCA2-1213-857	571436	cool white	5700	4437	192	6400	180	8228	169	9660	160	11435	150	120	82	857/369

VCA2-1213 - CRI 90

VCA2-1213-927	571437	warm white	2700	3324	144	4795	135	6164	127	7237	120	8567	112	120	92	927/369
VCA2-1213-930	571438	warm white	3000 (below BBL)	3541	154	5108	144	6567	135	7710	128	9127	120	120	92	930/369
VCA2-1213-931PW	571439	pearl white	3100	3470	150	5006	141	6437	132	7557	126	8945	117	120	92	931/369
VCA2-1213-932CW	571440	clear white	3200	3486	151	5029	141	6465	133	7591	126	8985	118	120	92	932/369
VCA2-1213-935	571441	neutral white	3500 (below BBL)	3576	155	5159	145	6632	136	7787	129	9217	121	120	92	935/369
VCA2-1213-940	571442	neutral white	4000 (below BBL)	3647	158	5260	148	6762	139	7940	132	9399	123	120	92	940/369
VCA2-1213-950	571443	cool white	5000	3823	166	5515	155	7090	146	8325	138	9854	129	120	92	950/369

VCA2-1213 - FOOD

VCA2-1213-MP	571444	Meat "Pink"	2000 "pink effect"	2468	107	3561	100	4578	94	5374	89	6362	83	120	82	820/369
VCA2-1213-MVi	571445	Meat "Vivid"	3100 "meat vivid"	2626	114	3806	107	4903	101	5709	95	6771	89	120	88	831/369
VCA2-1213-VBread	571446	VBread	2500 "VBread"	3339	145	4842	136	6237	128	7366	122	8776	115	120	88	825/369

ó p μ² 66 Ø J A d² 6R q² 66 p μ² 66 q zó s² Š: Š Š μ c t Š q² s óš =<0 d Š: T k j k' j N F < F 8 N I < I

Wymiary

VCA2-1211

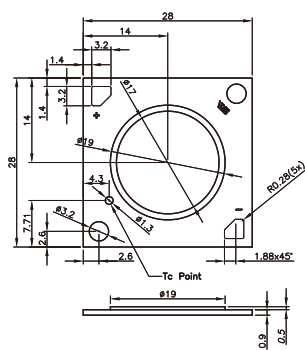

VCA2-1213

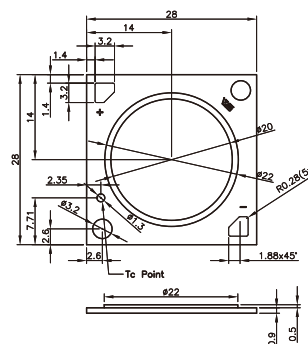

Emergency Complete

Z funkcją autodiagnostyki lub bez i zintegrowaną baterią

Parametry produktu

h c 2 ó c q 2 \$ \$ 2 dVUg \$µ \$
 Ø \$ ó c 2 q t c 2 z 2 ó s ó n S z z s \$ \$ Ø \$ ó ó n
 \$ \$ ó 2 ó
 T 2 2 ó \$ µ \$ 2 2 s c t J A t q \$
 e 2 q 2 \$ \$ q \$ µ \$ 2 2 s c t t q \$ r UV <=< F
 µ Ø Ve C <= E >
 w e z ó s 2 q \$ t z \$ t q \$ Ve D > < AB
 R c c ó 2 c ó \$ \$ U h 5
 p c 2 2 ó c \$ J q C q C < T
 R z p p \$ q 4 \$ h f B 5 \$ Ø q 2 Ø q
 T 2 2 q 2 \$ z z p 2 J q > B t q \$ 2 µ ó s q
 \$ ó s



Parametry elektryczne

e 2 2 q µ	Numer Katalogowy	k q 2 s Ø c \$	e \$ 2 µ z c q \$ 2 \$ Ø 2 2 s t q :	d ó s ó s 2 2 z p 2 Ø 2 2 s 4 5	d \$: \$ \$ µ Ø 2 2 s ó 4 5	e 2 ó s \$ s ó s c V V max.
-----------	------------------	-------------------	--	---------------------------------------	------------------------------------	--------------------------------

K111 - Wymiary (LxWxH): 200x39.6x25.5 mm

EMCc180.028	187552	3.2 V/3 Ah	3	2.5	250	10-300	350
-------------	---------------	------------	---	-----	-----	--------	-----

ó <=< µ ; s 2 \$ q z dVU

Wymiary

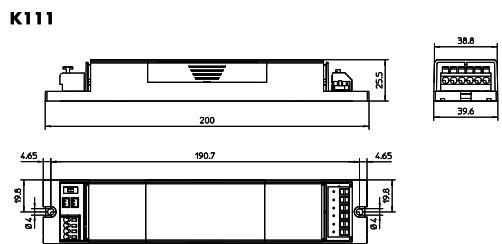

f Ø q 2 J b ===
 U t J >>>
 ó c z J A I : D
 s z J > C C

Akumulatory do awaryjnego użytku

Akumulator litowo-jonowy

T 2 2 q 2 \$ 2 z p J
 q > B t q \$ 8 2 µ ó s q \$ ó s
 p c 2 z p \$ 2 \$:
 R z p \$ q ó q c 2 2 2 s c t
 V d T ó = F < : < > F = F E C C > :



w 2 \$ \$ 2 2 s c s	Numer Kat.	R z p p \$ q	T 2 c c t 2 q 2 \$ z z p 2 n	h q 2 q 2 \$ R = < 0	e 2 \$ ó s 2 q 2 \$ 2 z p 2 d \$ p q 2 r	h q 2 q 2 \$ 2 z p 2 d \$ p q 2 R	d ó s ó s 2 2 z p 2 d \$ p q 2 s	T 2 2 p n
2.5	183208	LiFePO4 2IFR 18650	16	200	2.5 - 3.2 - 3.6	650 - 740 - 840	1.9 - 2.4 - 2.7	3

EasyLine DIP switch L Gen.2

Cechy produktu

b 2z z 2 Øq

Funkcje

h q śóś ć μ 2 2 ó Ujh

Parametry elektryczne

e 2 śóś śóś ćj >>> >B<r =<0
 T śś śóś C< D< Z
 w 2 śś qć 2 J =ED >F<r8< Z
 w 2 śś z ćj <8C =8C
 s ó ś ó ć Øś ć śj <8 C
 d 2 z 2 μ ć 2 śóś Ø ó ć 4f qpś >C<r ś zś >ECr
 qf =FECE
 h ć ó 2 ś q dVU ś ćśś śg μ ć:

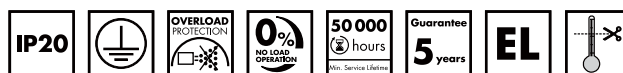

Parametry elektryczne

d 2 :	e 2 2	Numer kat.	e 2 S óś C<D<Z	h q śóś R	h q óri R ;	h q śóś UT R 4 C05	e 2 S óś śóś ć UT 4.5	pZU ć Øś ć ś 0 4A<r5	s q 2 ś 2 : Øś ć ś 0 4A<r5	p ś S =<< Z 0
26	ECXe 350.738	187585	220-240	230-190	24.5 / 310	200	40-130	<4	>93	<3
32.5						250				
39						300				
45.5						350				
38	ECXe 350.739	187586	220-240	330-280	26 / 330	200	90-190	<4	>95	<3
47.5						250				
57						300				
66.5						350				
48	ECXe 350.740	187587	220-240	420-360	34.6 / 346	200	120-240	<5	>95	<3
60						250				
72						300				
84						350				
45.5	ECXe 500.741	187588	220-240	330-280	26 / 330	350	40-130	<4	>94	<3
52						400				
58.5						450				
65						500				
63	ECXe 500.742	187589	220-240	450-385	34.6 / 342	350	90-180	<5	>95	<3
72						400				
81						450				
90						500				
71.5	ECXe 700.743	187590	220-240	460-395	34.6 / 340	550	40-130	<5	>95	<3
78						600				
84.5						650				
91						700				

Maksymalne wartości znamionowe

h c z o c s 2 z 2 μ o r i 2 o s 2 s o r i c 2 q s q z o c s o s μ Ø s o c s c s :

e c b 2 2 μ t	p c 2 2 Ø o 2		s s Ø o 2		p c 2 2 c o r i 2 s		s s c o r i 2 s		d 2 z 2 μ 2 c c 2 2 2 o z o c o	o s o r i
	°C min.	°C max.	% min.	% max.	°C min.	°C max.	% min.	% max.		
187585	-25	+50	10	90	-40	+85	5	95	+75	IP20
187586								+75		
187587								+80		
187588								+75		
187589								+80		
187590								+80		

Wymiary

e c z 2 μ t	p Ø q	U t 2 4 5	o c z Ø 4 5	s z ó 4 5
187585	M106	168	30	21
187586				
187588				
187587	M107	210	30	21
187589				
187590				

M106

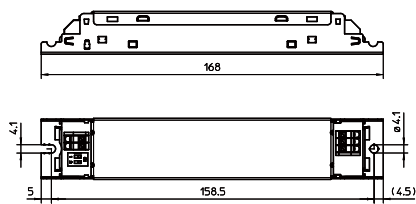

M107

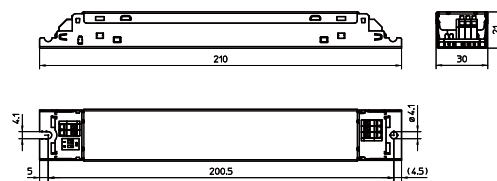

EasyLine DIP switch L 120V

Cechy produktu

b 2z z 2 Øq

Funkcje

h q sós ct µ 2 2 ó Ujh

Parametry elektryczne

e 2 Sós Sós c j =>< >EE r =<0
 T µ Sós C< D< Z
 w 2 S S q c 2 J =ED >F< r8< Z
 s ó S ó c ØS c S J <8 C
 d 2z 2µc 2 Sós Ø ó c 4f qp S >C< r s z S >EC r
 qf =FEAA=
 h c ó 2 S q dVU S c s S Sg µ c:

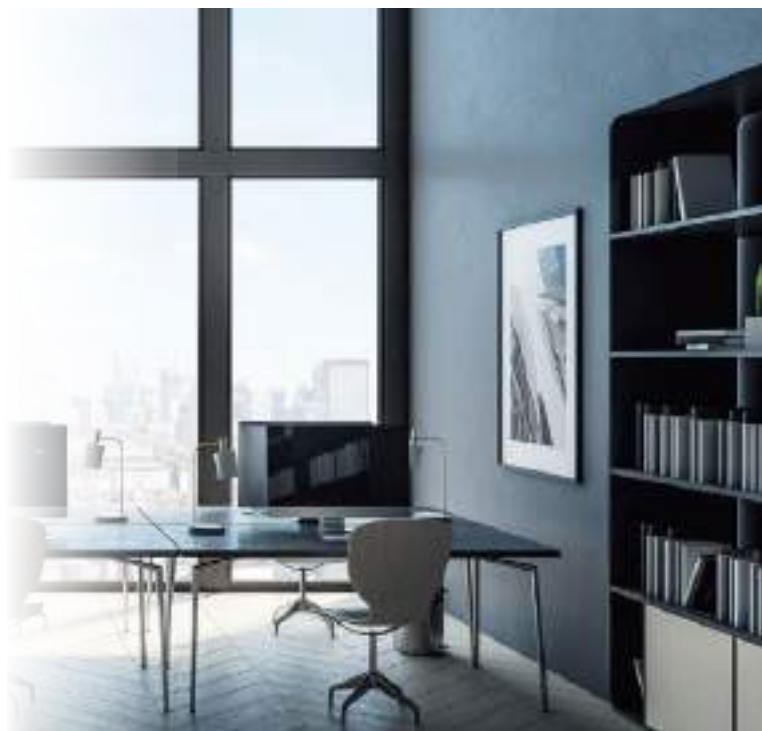

Parametry elektryczne

d 2 : sós	e 2 2 qcm	Numer kat.	e 2 Sós C< Ø< Z r	h q Sós R	h q ó R ;	h q sós UT R 4 CO5	e 2 Sós sós c UT 4.5	pZU c S 0 4A< r 5	s q 2 s 2 : ØS c S 0 4A< r 5	p S S =<< Z 0
26	ECXe 350.623	187330	120-277	420-175	25 / 200	200	40-130	<7	>93	<3
33						250				
39						300				
46						350				
48	ECXe 350.624	187331	120-277	750-320	45 / 245	200	120-240	<3	>95	<3
60						250				
72						300				
84						350				
46	ECXe 500.625	187332	120-277	605-250	30 / 300	350	40-130	<4	>94	<3
52						400				
59						450				
65						500				
63	ECXe 500.626	187333	120-277	785-340	45 / 245	350	90-180	<2	>94	<3
72						400				
81						450				
90						500				
72	ECXe 700.627	187334	120-277	830-355	45 / 245	550	40-130	<2	>94	<3
78						600				
85						650				
91						700				

Wymiary

f Øq 2 J d E:>
 U t J >F<
 o c z J A<
 s z J >=

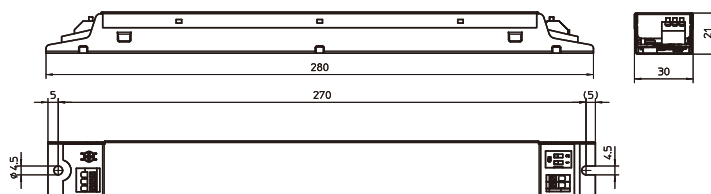

ComfortLine DIP switch L-DALI2

Cechy produktu

b 2ż ż 2 Øq

Funkcje

h g śóś ć μ 2 2 ó Ujh

Parametry elektryczne

e 2 śóś śóś ć j >>> >B<r =<0
 T μś śóś C< D< Z
 w 2 śr ś qć 2 J=I F >EDr8< Z
 w 2 óśśś ż ć j <8C =8C
 s ó ś ó ć Øś ć ś j <8 C
 d 2ż 2μć 2 śóś Ø ó ć 4f qpđ >C<r ś zś >ECr
 qj 2 =FEAAD
 h ć ó 2 ś q dU ś ćśś śg μ ć:



Parametry elektryczne

d 2 : śóś s	e 2 2 qćμ	Numer kat.	e 2 S óś C<D< Z r	h g śóś R	h g óñ R ;	h g śóś UT R 4 C05	e 2 S óś śóś ć UT 45	pZU ć Øś ć ś 0 4A<r5	s q 2 s 2 : Øś ć ś 0 4A<r5	p ś S =<< Z 0
26	ECXd 350.628	187335	220-240	230-205	31 / 170	200	40-130	<5	>90	<3
32.5						250				
39						300				
45.5						350				
38	ECXd350.665	187416	220-240	330-295	31 / 200	200	90-190	<4	>92	<3
47.5						250				
57						300				
66.5						350				
48	ECXd 350.629	187336	220-240	405-370	37 / 240	200	120-240	<4	>93	<3
60						250				
72						300				
84						350				
45.5	ECXd 500.630	187337	220-240	325-290	33 / 200	350	40-130	<4	>91	<3
52						400				
58.5						450				
65						500				
63	ECXd 500.631	187338	220-240	440-405	37 / 256	350	90-180	<5	>92	<3
72						400				
81						450				
90						500				
71.5	ECXd 700.632	187339	220-240	440-405	37 / 251	550	40-130	<4	>92	<3
78						600				
84.5						650				
91						700				

Wymiary

f Øq 2j d E:>
 U ł J>F<
 o ć ż JA<
 s ż J>=

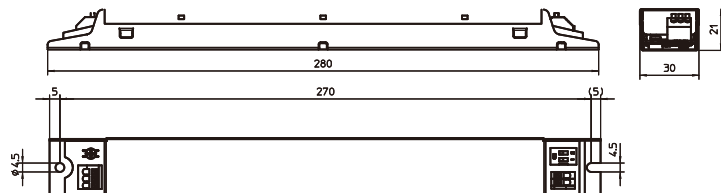

EasyLine DIP switch L-LV

Cechy produktu

b 2 z z 2 Øg

Funkcje

h g śśś ć μ 2 2 ó Ujh

Parametry elektryczne

e 2 śśś śśś ć j >>> >B< r =<0

T μś śśś C< D< Z

w 2 ś ś qć 2 J =ED >F< r

w 2 śśś z ć j <8C =8C

s ó ś ó ć Øś ć ś j <8 C

d 2 z 2 μ ć 2 śśś Ø ó ć 4f g p 5 D< r

h ć ó 2 ś g dVU ś ćśś śg μ ć:



Parametry elektryczne

d 2 : śśś s	e 2 2 gćμ	Numer kat.	e 2 śśś C<D< Z r	h g śśś R	h g ó R ;	h g śśś UT R 4 CO5	e 2 śśś śśś ć UT 4 5	pZU ć Øś ć ś 0 4A< r 5	s g 2 s 2 : Øś ć ś 0 4A< r 5	p ś ś =<< Z 0
10.2	ECXe 350.722	187547	220-240	95-88	13.6 / 118	200	15-51	<8	>86.5	<3
12.8						250				
15.3						300				
17.9						350				
25.5	ECXe 650.723	187548	220-240	17-158	17.4 / 154	500	15-51	<4	>91	<1
28						550				
30.6						600				
33.2						650				
35.7	ECXe 1050.724	187549	220-240	203-197	16.8 / 162	700	15-51	<4	>91	<1
38.3						750				
40.8						800				
40.8						850				
41.4						900	15-46			
41.8						950	15-44			
40						1000	15-40			
39.9						1050	15-38			
58.7	ECXe 1500.725	187550	220-240	312-284	36.7 / 188	1150	15-51	<4	>91.5	<1
60						1200	15-50			
60						1250	15-48			
59.8						1300	15-46			
60.8						1350	15-45			
58.8						1400	15-42			
60.9						1450	15-42			
60						1500	15-40			

Maksymalne wartości znamionowe

h c z ó c ś 2 z 2 μ ó n 2 ó s 2 ś ó n c 2 q ś q z ó c ś ó s μ ∅ ś ó c ś c ś :

e c b ² μ t	μ c 2 2 ∅ ó 2 2 z c °C min.	°C max.	s ś ∅ ó 2 2 z c % min.	% max.	μ c 2 2 ó n 2 ś 2 z c °C min.	°C max.	s ś ó n 2 ś 2 z c % min.	% max.	d 2 z 2 μ 2 c c 2 2 2 ó z ó s ó °C	o ś ó n
187547	-20	+60	20	90	-25	+60	20	90	+80	IP20
187548									+85	IP20
187549					-25	+80			+80	IP20
187550									+90	IP20

Wymiary

e c b ² μ t	p ∅ q	U t 2 4 5	o c z ∅ 4 5	s z 6 4 5
187547	M6	210	30	21
187548				
187549				
187550	M7	280	30	21

Wymiary

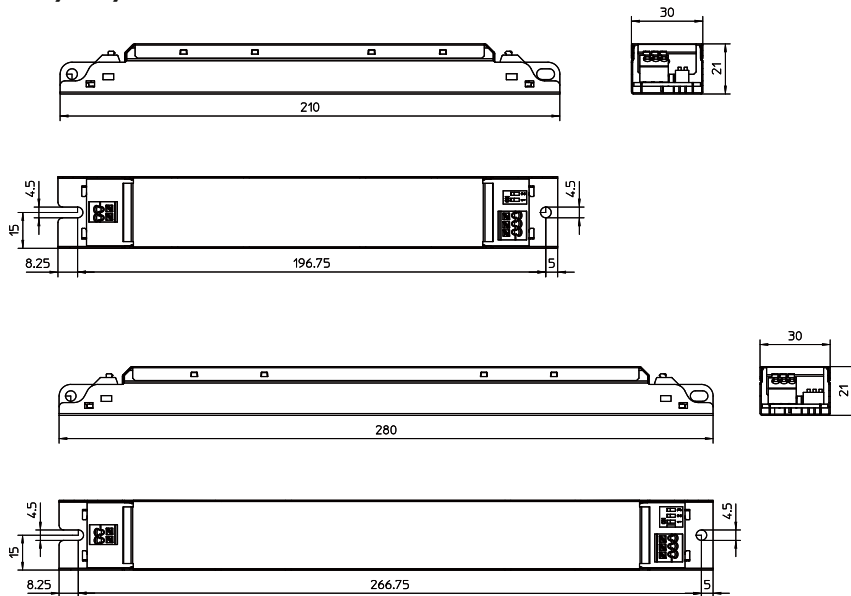

EasyLine DIP sitch L-LV DALI

Cechy produktu

b 2z z 2 Øq

Funkcje

h g sós ćł μ 2 2 ó Ujh

Parametry elektryczne

e 2 sós sós ćj >>< >B< r =<0
 T μ sós C< D< Z
 w 2 s s qć 2 J=ED >F< r
 w 2 s z s z ćł <8C =8C
 s ó s ćł ó ćł Øs ć sJ <8 F
 d 2 z 2 μ ć 2 sós Øó ć 4f qp D< r
 h ć ó 2 s q dVU s ć s s s q μ ć:

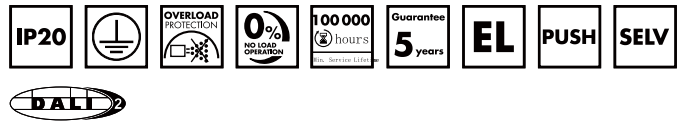

Maksymalne wartości znamionowe

h ćł ó ćł s 2z 2 μ óń 2 ós 2 s óń ć 2q s q z óć s ós μ Ø s ó ć s ć s :

e ć b 2 μ t	p ć ć 2 2 Ø ó 2 2 z ć		s s ćł Ø ó 2 2 z ć		p ć ć 2 2 ć óń 2 s 2 z ć		s s ćł ć óń 2 s 2 z ć		d 2 z 2 μ 2 ć ć 2 2 o s 2 ó z ó s ó óń
	°C min.	°C max.	% min.	% max.	°C min.	°C max.	% min.	% max.	
187653	-25	+60	10	90	-25	+85	10	90	+75
187654									+80
187655									

Żywotność

ć ć 2 2 óń Ø ó óń z ó s ó

Rz 2 μ 2 2 ó	Numer katalogowy			
	187653		187654, 187655	
all types	75°C	65°C	80°C	70°C
hrs.	50.000	100.000	50.000	100.000

Wymiary

f Øq 2 J d E:D
 U ł J >F<
 o ć z J A<
 s z J >=

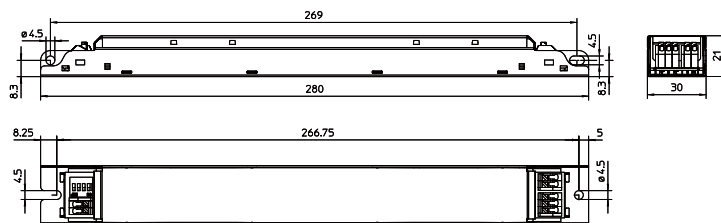

Parametry elektryczne

d ² : s	e ² : g	Numer kat.	e ² : C<D<Z r	h : R	h : R ;	h : R 4 CO5	e ² : UT 4 5	pZU : 0 4A< r 5	s : 0 4A< r 5	p : 0
5.1	ECXd 700.778	187653	220-240	180-167	7.3 / 40	100	15-51	4	90	2
7.7										
10										
13										
15										
18										
20										
23										
26										
28										
31										
33										
35										
18	ECXd 1050.779	187654	220-240	262-244	12 / 40	350	15-51	3	91	2
20										
23										
26										
28										
31										
33										
36										
38										
41										
43										
46										
48										
50										
49										
54	ECXd 1800.780	187655	220-240	372-343	14 / 32	1050	15-50	3	92	1
56										
59										
61										
64										
65										
68										
70										
73										
74										
74										
75										
75										
75										
75										
76										

Linear Optics 3R for SMD Comfort-B HO 90 single lenses 500 mm IP40

Cechy produktu

$d \leq 2 \mu m$
 $d \leq 2 \mu m$
 $s \leq 4 \mu m$
 $d \leq 2 \mu m$
 $d \leq 2 \mu m$

Właściwości oświetleniowe

$T_c \leq 40^\circ C$
 $U_g \leq 2.8V$
 $U_c \leq 2.8V$
 $U_c \leq 2.8V$



k	θ	d	Numer Kat.	s	d	V_{gZ}	U_g	U_c	s	α
High Rack		96322	573686	UGR	Clear	94		IP40	107	140
Diffuse 90°		96322	573687	CLC	Diffuse	86		IP40	107	140
Medium 60°		96323	573688	UGR, E95	Clear	95		IP40	95	140

Wymiary

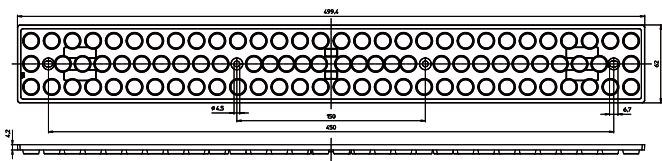

rozkład światła z modułami LED VS (z Cree JE2835)

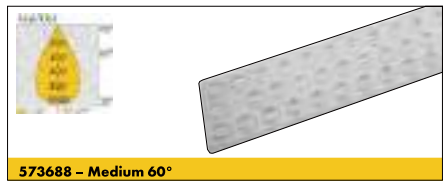
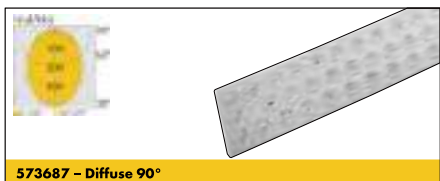
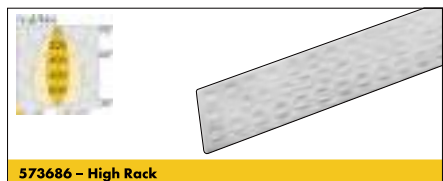

Linear Optics 3R for SMD Comfort-B 60 single lenses 500 mm IP40

Cechy produktu

$d \leq 2 \mu m$
 $d \leq 2 \mu m$
 $s \leq 4 \mu m$
 $d \leq 2 \mu m$
 $d \leq 2 \mu m$

Właściwości oświetleniowe

$T \leq 42^\circ C$
 $CRI \geq 90$
 $VI C \geq 2$
 $NI CO$



Parametry elektryczne

k	§ 2	d gcp	Numer Kat.	s 2 ós ós § μ §	d 2 c §	Vgł. 0	ó	o § óri	s 2 l 2	atq z 2 z 2 §
Extra Wide	110°	96304	571094	UGR, CLC, E95	clear	95		IP40	74.5	160
Wide	90°	96300	569527	UGR, E95	clear	95		IP40	76.3	160
Medium	60°	96303	571093	UGR, E95	clear	95		IP40	87.1	140
High Rack		96302	571092	UGR, E95	clear	95		IP40	90.5	140
High Rack CLC		96302	572154	UGR, CLC	clear	91		IP40	90.5	140
Retail SYM		96301	569528	UGR, CLC, E95	clear	95		IP40	87.2	140
Diffuse	110°	96304	570378	CLC	diffuse	94		IP40	72.4	160

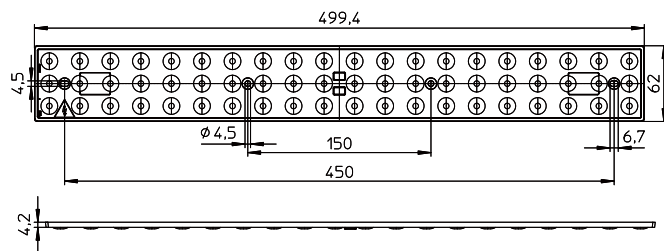

light distributions with VS LED modules (with Cree JE2835)



Linear Grids 1R for SMD Light&Dark

Cechy produktu

d² c² J h T Ø 8 ó² μ Ø c ó
 d² z² μ² q ó² μ² c² c² J F < T
 f q t t S q z² S & μ \$ B <
 d ó² z² z² c z
 h & ó n & z² c
 o S z² = k E z z S z² ó² S μ Ø z² q S
 z z q ó c S & S
 k² z² z² = k E & S > F <



Parametry elektryczne

UGR

e ² z ² q z	Numer kat.	k q z ² s z z S	b μ	s ² t ² t	μ z ² z ² S :
91400	571824	1 Rx7 short ends	white	35	108
91400	571825	1 Rx7 short ends	black	35	108
91400	574284	1 Rx7 short ends	translucent	35	108
91401	571880	1 Rx7 to line up	white	35	108
91401	571881	1 Rx7 to line up	black	35	108
91401	573725	1 Rx7 to line up	translucent	35	108
91410	571882	1 Rx4 short ends	white	20	108
91410	571883	1 Rx4 short ends	black	20	108
91410	574285	1 Rx4 short ends	translucent	20	108

Wymiary

Type 91400

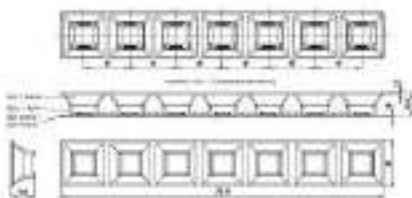

Type 91410

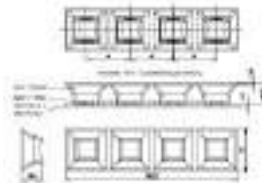

Type 91401

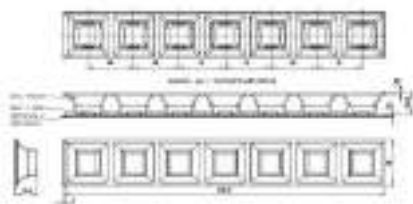

Grids 2R for SMD Light&Dark 2Rx2 80mm

Cechy produktu

d² c² S² J h T² Ø² 8ó² μ² Ø² c² ó²
 d² z² 2μ² g² ó² 2μ² c² c² 2 J F < T²
 f² q² t² S² g² z² S² S² μ² S² B <²
 d² ó² 2² S² z² S² c² z²
 d² c² S² ó² S²
 o² S² z² > k > z² z² S² S² ó² S²



Parametry elektryczne

e ² 2 ² q z ²	Numer kat.	k g 2 s ² z zó S ²	b μ	s 2 t 2 ² t	μ 2 z 2 2 S ² :
91420	572669	2Rx2 short ends	white	20	280
91420	572670	2Rx2 short ends	black	20	280
91420	574154	2Rx2 short ends	translucent	20	280



Odpowiednia optyka VS

o ² z ²	f z ² d 2 q S ² 2 ²	p z ² S ²
2Rx2	1Rx2 (2 times)	91471, 91472

Wymiary

Type 91420

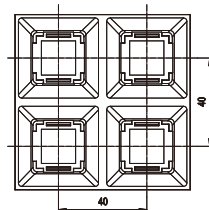

Assembly view / Zusammenbau darstellung

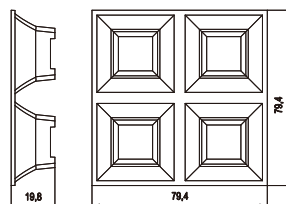
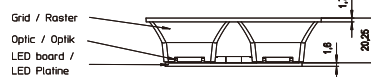

Linear Optics 1R for SMD Light&Dark

Cechy produktu

U gŚ q dVU >FAC8A<A<8CDA< ŚC<C<
 2ś p Śś óń q óć qŚ q dVU8
 2ż 2μ Ś ó ć ć 2 qŚ q² Ś dVU 2 ó ć ż 4p
 >FAC ŚA<A<5
 d 2 ć Ś J hd d R
 d 2ż 2μ² q ó 2μ² ć ć 2 2J F<T
 f qμć ż Ś μć B<
 f ć μ ć 2 Ø d A Ś Ś
 d 2ż 2μ ć q ż ó² Ś Ø d A J <8C e



Właściwości oświetlenia

T d 4 2 2 Ø 2 Ś 2 J Ø q Ś Ś q óń μ Ś
 ć ć 2 Ø ćś 2 μ ćś q ż 2 2 q² Ś Ś Ś
 q X k j 2 μ 2 2 ć q z óś μ Ś Ś



k q 2 ś z Ś	e 2 2 q ż	Numer kat.	s 2 óś óś Ś μć Ś	k q 2 ś z z óś	Vgć ż 0	s 2 t 2 t	μ 2 z 2 Ś
Medium 65°	91451	571826	UGR, CLC	1Rx7	91	14	324
Wide 90°	91452	571827	UGR, CLC	1Rx7	92	18	324
ASYM	91453	572478	UGR, CLC	1Rx7	88	14.8	324
Medium 65°	91461	571884	UGR, CLC	1Rx4	91	7.7	540
Wide 90°	91462	571885	UGR, CLC	1Rx4	92	10	540
ASYM	91463	572479	UGR, CLC	1Rx4	88	8.2	540
Medium 65°	91471	572628	UGR, CLC	1Rx2	91	3.5	390
Wide 90°	91472	572636	UGR, CLC	1Rx2	92	4.7	390

ó h Ś z 2 Ø Ś z



Wymiary

Type 91452

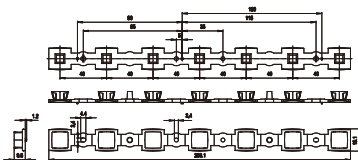

Type 91451

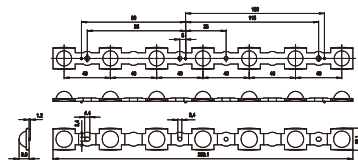

Type 91453

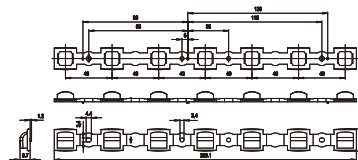

Type 91462

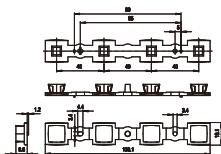

Type 91461

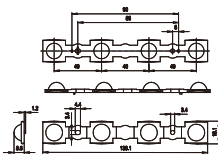

Type 91463

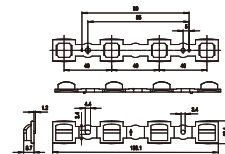

Type 91471

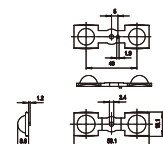

Type 91472

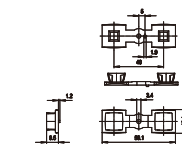

Charakterystyka optyki - CRI > 90

MC< T 800 zS cS
TkJ k² NI <

e ² z		e c z ² ; b μ hTS SŠ ² T ² z ² 4 5 45	S ² z ²	α c z ² z ² Ø z ² 6 b	p	Š Š μ 66 S ² q ² s 66	b q zS										
				=C< R	><< R	A<< R	AC< R	C<< R	L C<< R	C<< R							
				μ μ ; s	μ μ ; s	μ μ ; s	μ μ ; s	μ μ ; s									
WU-M-694-W/B 28LEDs - 280mm																	
WU-M-694-W/B-927/965		572455	572457	warm white	2700	430	132	370	148	835	139	960	136	1335	127	927/349	927/339
				cool white	6500	455	160	600	156	875	147	1010	143	1405	133	965/349	965/339
WU-M-695-W/B 56LEDs - 560mm																	
WU-M-695-W/B-927/965		572469	572471	warm white	2700	865	132	1140	148	1685	139	1920	136	2665	127	927/349	927/339
				cool white	6500	910	160	1300	156	1755	147	2075	143	2805	133	965/349	965/339

6 p μ² 66 Ø J A d² 6Rq² 66 p μ² 66 q z6 s² Š Š Š μ c t Š q² s 6Š = < 0

Wymiary

STC = Małe połączenie górne

WU-M-694-W/B

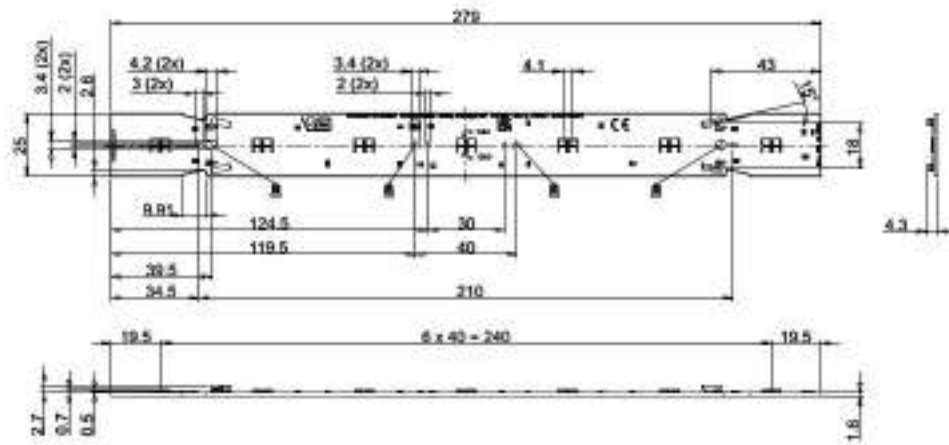

WU-M-695-W/B

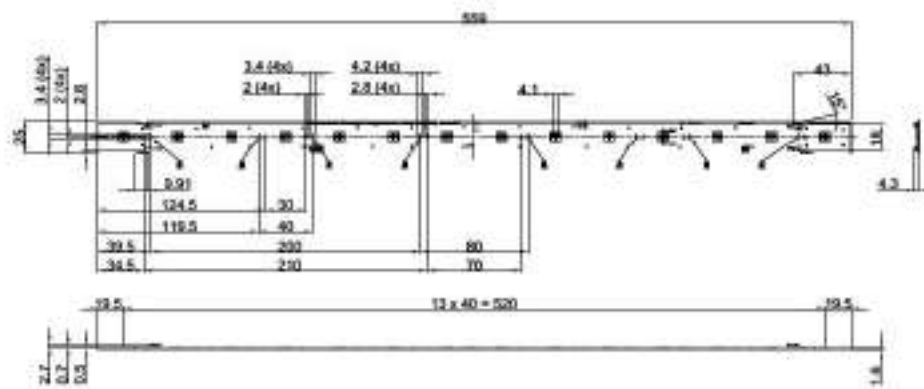

LED SMD Light& Dark Square

Cechy produktu

- Wysokość: 4,3 mm
- Szerokość: 62 mm
- Długość: 62 mm
- Ciężar: 0,25 kg
- Temperatura pracy: -40°C do +40°C
- Temperatura otoczenia: -25°C do +35°C
- Temperatura przechowywania: -40°C do +60°C
- Ciężar: 0,25 kg
- Wysokość: 4,3 mm
- Szerokość: 62 mm
- Długość: 62 mm
- Ciężar: 0,25 kg
- Temperatura pracy: -40°C do +40°C
- Temperatura otoczenia: -25°C do +35°C
- Temperatura przechowywania: -40°C do +60°C

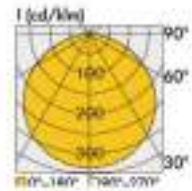

Parametry elektryczne Wersja bez SELV

at_p = 50 °C

e ² 2 q z	I _p dVU	p c ² ŚóŚ UT =C< R	>>< R	AC< R	C<< R	E<< R	ś c ² 4 r; b5	=C< R	>>< R	AC< R	C<< R	E<< R
WU-M-709-W/B	1,6	10,6	10,7	10,9	11,3	11,7	-4,49	1,6	2,1	3,8	5,6	8,2

Wymagane jest zastosowanie zewnętrznego sterownika prądu stałego LED.

Parametry elektryczne Wersja z SELV

at_p = 50 °C

e ² 2 q z	I _p dVU	p c ² ŚóŚ UT =<< R	=C< R	>>< R	>C< R	AC< R	ś c ² 4 r; b5	=C< R	=C< R	>>< R	>C< R	AC< R
WU-M-709-W/B-IV	1,6	21,3	21,7	22,1	22,5	23,4	-8,98	2,1	3,2	4,4	5,6	8,2

Wymagane jest zastosowanie zewnętrznego sterownika prądu stałego LED.

Wymiary

WU-M-709-W/B

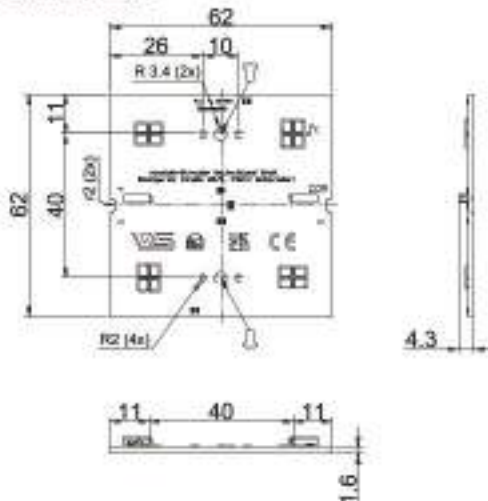

Linear Optics 1R for SMD W2- IP65

Cechy produktu

U g d V U c g S s o A<A<8>FAC6 S CDA<6
 p r o n i g o c d V U 4 2 g 5
 d 2 c S J h T
 d 2 z 2 μ 2 g o 2 μ 2 c c 2 2 J = << T
 f 2 c g Ø d B
 o S r i J h DC 4 2 o c z S S 5
 f g 2 q c c S J b < F ; Ca
 h z S o d U 2 μ c 2 q q S μ S c
 q q 2 z q o S z 2 c q z q S S S c
 z 2 q o :



k S 2	d g c p	Numer katalogowy	s 2 o S o S S μ S	V g e z 0	s 2 t 2 t	s S 4 s Z 5	α g z 2 2 S :
Wide 90°	96700	571820	clear	91	137	570x53x9.5	84
Batwing 145°	96701	571821	clear	90	156	570x53x15	
Medium 60°	96703	571823	klar	90	139	570x53x10.5	84

o h S z 2 2 o S o S 2

Wymiary

Type 96700 – Wide 90°

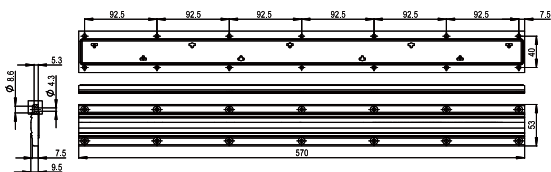

Type 96701 – Batwing 145°

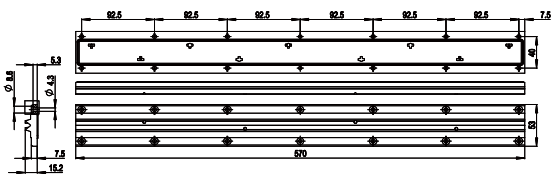

Type 96703 – Medium 60°

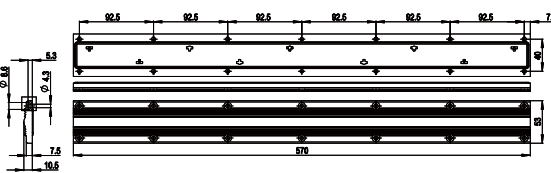

LED Line SMD W2 Comfort Gen. 2

Cechy produktu

- s Øq 2 q dVU q Ś ćł 2óśś 2 2 Ś
- Ś ĩ Ś Ś
- s Ś
- s qØ ØDDJ E< ><
- s qØ ØDE; DD FJ =B< ><
- s qØ ØDI; DE <J >F< ><
- s qØ ØEAJ C<< ><
- s qØ ØE=; DE >J CD< ><
- h q 2 Ś ŚJ >C< R; AC< R; C<< R;
- D<< R; E<< R
- s Øq 2 ć 2óśśŚ z ć8 óś 2µŚ ł µØ
- q
- b Ś zŚ =><

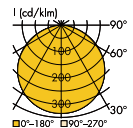

Parametry elektryczne

at_p = 50 °C

e ² 2 q z	µ dVU	p ć 2 Śóśś UT >C< R r	AC< R r	C<< R r	D<< R r	E<< R r	s ó Ś ć ć 2 4 r; b5	p Ø ó >C< R s	AC< R s	C<< R s	DC< R s	EC< R s
LED Line SMD W2 Comfort Gen. 2 – L07												
WU-M-666	6	5.4	5.6	5.8	5.9	6	-2.23	1.4	2	2.9	3.6	4.2
LED Line SMD W2 Comfort Gen. 2 – L14												
WU-M-667	6	5.4	5.6	5.8	5.9	6	-2.23	1.4	2	2.9	3.6	4.2
WU-M-668	12	10.9	11.2	11.7	11.9	12.1	-4.45	2.7	3.9	5.8	7.1	8.4
LED Line SMD W2 Comfort Gen. 2 – L28												
WU-M-669	12	10.9	11.2	11.7	11.9	12.1	-4.45	2.7	3.9	5.8	7.1	8.4
WU-M-670	24	21.8	22.4	23.3	23.7	24.1	-8.90	5.4	7.8	11.7	14.2	16.9
LED Line SMD W2 Comfort Gen. 2 – L50												
WU-M-673	42	38.1	39.2	40.8	41.5	42.2	-15.58	9.5	13.7	20.4	24.9	29.6
LED Line SMD W2 Comfort Gen. 2 – L56												
WU-M-671	24	21.8	22.4	23.3	23.7	24.1	-8.90	5.4	7.8	11.7	14.2	16.9
WU-M-672	48	43.5	44.7	46.6	47.4	48.3	-17.81	10.9	15.7	23.3	28.5	33.8

p µ 2 óś 2 Śóś Ś Ø óJ =<0 **Wymagane jest zastosowanie zewnętrznego sterownika prądu stałego LED.**

Maksymalne wartości znamionowe

h ćz ó ć Ś z z 2µ óń 2 óś 2 Ś óń ć 2q Ś q z óć Ś óśµØ Ś óć Ś q :

e ² 2 q z	h q Ø ó 4 R5	wżć ć ć 2 2ó °C min.	zóś ó °C max.	wżć ć ć 2 ćóń 2 Ś °C min.	°C max.	d z z 2µ q ó 2µ 2 2µ q ó qż ó µ óś =<< Z 4 R5
All types	700	-20	+80	-20	+70	900

Żywotność

f<; S=<
ł q Ś 2 óń Ś ćś ć ć 2 ć zóś

	250 mA			350 mA			500 mA			600 mA			700 mA		
	40 °C	50 °C	80 °C	40 °C	50 °C	80 °C	40 °C	50 °C	80 °C	40 °C	50 °C	80 °C	40 °C	50 °C	80 °C
All types	> 72,000	> 72,000	> 55,000	> 72,000	> 72,000	> 54,000	> 72,000	> 72,000	> 51,000	> 54,000	> 54,000	> 50,000	> 36,000	> 36,000	> 36,000

Charakterystyka optyczna - CRI > 80

MC < T
T k] k² NF <

e² ² q z	Numer katalogowy Połączenie			b μ	α c² ² Ø ²6 b	Σ Σ μ 66 Σ ² q² s 66										b q zS	
	dół (TC)	górn (BC)	dół (STC)			330 mA lm	330 mA lm/W	370 mA lm	370 mA lm/W	500 mA lm	500 mA lm/W	600 mA lm	600 mA lm/W	700 mA lm	700 mA lm/W	300 mA lm	300 mA lm/W
LED Line SMD W2 Comfort Gen. 3 - L07																	
WU-M-666-TC/STC-827	573064	—	on request	WW	2700	345	170	340	173	475	163	565	138	645	153	827/349	
WU-M-666-TC/STC-830	570726	—	573284	WW	3000	350	185	350	178	490	168	580	140	665	157	830/349	
WU-M-666-TC/STC-840	570727	—	573285	NW	4000	365	195	370	188	520	178	615	172	705	167	840/349	
WU-M-666-TC/STC-850	571453	—	on request	CW	5000	365	195	370	188	520	178	615	172	705	167	850/349	
WU-M-666-TC/STC-865	571454	—	on request	CW	6300	360	191	360	184	503	173	600	168	685	162	865/349 /359	
LED Line SMD W3 Comfort Gen. 2 - L14																	
WU-M-667-TC/BC/STC-827	571842	on request	574257	WW	2700	345	170	340	173	475	163	565	138	645	153	827/349	
WU-M-667-TC/BC/STC-830	570728	on request	on request	WW	3000	350	185	350	178	490	168	580	140	665	157	830/349	
WU-M-667-TC/BC/STC-840	570729	on request	on request	NW	4000	365	195	370	188	520	178	615	172	705	167	840/349	
WU-M-667-TC/BC/STC-850	570730	on request	on request	CW	5000	365	195	370	188	520	178	615	172	705	167	850/349	
WU-M-667-TC/BC/STC-865	570731	on request	on request	CW	6300	360	191	360	184	503	173	600	168	685	162	865/349 /359	
WU-M-668-TC/BC/STC-827	572553	on request	on request	WW	2700	490	179	675	173	950	163	1125	138	1290	153	827/349	
WU-M-668-TC/BC/STC-830	570732	on request	573356	WW	3000	305	185	695	178	980	168	1160	140	1330	157	830/349	
WU-M-668-TC/BC/STC-835	573052	on request	on request	WW	3500	310	187	705	180	990	170	1175	145	1345	159	835/349	
WU-M-668-TC/BC/STC-840	570733	on request	on request	NW	4000	330	195	725	188	1035	178	1225	172	1405	167	840/349	
WU-M-668-TC/BC/STC-850	570734	573159	on request	CW	5000	330	195	725	188	1035	178	1225	172	1405	167	850/349	
WU-M-668-TC/BC/STC-865	570735	571455	on request	CW	6300	320	191	720	184	1010	173	1195	168	1370	162	865/349 /359	
LED Line SMD W3 Comfort Gen. 2 - L28																	
WU-M-669-TC/BC/STC-827	571843	on request	on request	WW	2700	490	179	675	173	950	163	1125	138	1290	153	827/349	
WU-M-669-TC/BC/STC-830	570736	570773	570753	WW	3000	305	185	695	178	980	168	1160	140	1330	157	830/349	
WU-M-669-TC/BC/STC-840	570737	570774	570754	NW	4000	330	195	725	188	1035	178	1225	172	1405	167	840/349	
WU-M-669-TC/BC/STC-850	570738	570775	570755	CW	5000	330	195	725	188	1035	178	1225	172	1405	167	850/349	
WU-M-669-TC/BC/STC-865	570739	570776	570756	CW	6300	320	191	720	184	1010	173	1195	168	1370	162	865/349 /359	
WU-M-670-TC/BC/STC-827	571745	on request	574258	WW	2700	495	179	1335	173	1905	163	2755	138	2585	153	827/349	
WU-M-670-TC/BC/STC-830	570740	570777	570757	WW	3000	1005	185	1395	178	1960	168	2320	140	2660	157	830/349	
WU-M-670-TC/BC/STC-835	573076	573103	on request	NW	3500	1015	187	1410	180	1980	170	2345	145	2690	159	835/349	
WU-M-670-TC/BC/STC-840	570741	570778	570758	NW	4000	1065	195	1475	188	2070	178	2455	172	2810	167	840/349	
WU-M-670-TC/BC/STC-850	570742	570779	570759	CW	5000	1065	195	1475	188	2070	178	2455	172	2810	167	850/349	
WU-M-670-TC/BC/STC-865	570743	570780	570760	CW	6300	1005	191	1490	184	2020	173	2390	168	2745	162	865/349 /359	
LED Line SMD W3 Comfort Gen. 2 - L50																	
WU-M-673-TC/BC/STC-830	574218	on request	570769	WW	3000	1760	185	2440	178	3400	168	4060	140	4655	157	830/349	
WU-M-673-TC/BC/STC-840	570752	570789	570770	NW	4000	1860	195	2580	188	3625	178	4290	172	4920	167	840/349	
WU-M-673-TC/BC/STC-850	on request	on request	570771	CW	5000	1860	195	2580	188	3625	178	4290	172	4920	167	850/349	
WU-M-673-TC/BC/STC-865	on request	on request	570772	CW	6300	1815	191	2515	184	3535	173	4185	168	4800	162	865/349 /359	
LED Line SMD W3 Comfort Gen. 2 - L56																	
WU-M-671-TC/BC/STC-827	571844	on request	574259	WW	2700	495	179	1335	173	1905	163	2755	138	2585	153	827/349	
WU-M-671-TC/BC/STC-830	570744	570781	570761	WW	3000	1005	185	1395	178	1960	168	2320	140	2660	157	830/349	
WU-M-671-TC/BC/STC-840	570745	570782	570762	NW	4000	1065	195	1475	188	2070	178	2455	172	2810	167	840/349	
WU-M-671-TC/BC/STC-850	570746	570783	570763	CW	5000	1065	195	1475	188	2070	178	2455	172	2810	167	850/349	
WU-M-671-TC/BC/STC-865	570747	570784	570764	CW	6300	1005	191	1490	184	2020	173	2390	168	2745	162	865/349 /359	
WU-M-672-TC/BC/STC-827	571744	on request	574260	WW	2700	1955	179	2710	173	2805	163	4505	138	5165	153	827/349	
WU-M-672-TC/BC/STC-830	570748	570785	570765	WW	3000	2010	185	2790	178	3920	168	4640	140	5320	157	830/349	
WU-M-672-TC/BC/STC-835	573075	on request	on request	NW	3500	2025	187	2820	180	3965	170	4690	145	5360	159	835/349	
WU-M-672-TC/BC/STC-840	570749	570786	570766	NW	4000	2120	195	2930	188	4145	178	4905	172	5625	167	840/349	
WU-M-672-TC/BC/STC-850	570750	570787	570767	CW	5000	2120	195	2930	188	4145	178	4905	172	5625	167	850/349	
WU-M-672-TC/BC/STC-865	570751	570788	570768	CW	6300	2075	191	2875	184	4045	173	4785	168	5485	162	865/349 /359	

>E<< b SA<<< b M&S² ² Ωμ4 s BAC<< b SB<<< b M c² μ² Ωμ4 s BC<<< b SD<<< b M S² Ωμ4 s 5
 6 p μ² 66 Ø J A d² 6Rq² 66 p μ² 66 q z6 s² Σ Σ Σ μ ct Σ² 66 =<0

LED Line SMD W2 Easy Gen. 2

Cechy produktu

- Wysoka wydajność światła
- Długość życia do 50 000 godzin
- Wysoka jakość światła
- Szeroki zakres temperatur pracy
- Wyjątkowo niskie zużycie energii
- Wyjątkowo niskie koszty eksploatacji
- Wyjątkowo niskie koszty inwestycyjne
- Wyjątkowo niskie koszty utrzymania
- Wyjątkowo niskie koszty obsługi
- Wyjątkowo niskie koszty naprawy
- Wyjątkowo niskie koszty demontażu
- Wyjątkowo niskie koszty wywozu



Parametry elektryczne

at_p = 50 °C

Wariant	Wysokość (mm)	Prędkość światła (lm)	Prędkość światła (lm/W)	Prędkość światła (lm)	Prędkość światła (lm/W)	Prędkość światła (lm)	Prędkość światła (lm/W)	Prędkość światła (lm)	Prędkość światła (lm/W)	Prędkość światła (lm)	Prędkość światła (lm/W)	
LED Line SMD W2 Easy Gen. 2 - L28												
WU-M-700	35	18.5	18.9	19.1	19.3	19.8	-7.21	2.8	4.7	5.7	6.8	9.9
LED Line SMD W2 Easy Gen. 2 - L56												
WU-M-701	70	37.0	37.9	38.3	38.6	39.5	-14.42	5.6	9.5	11.5	13.5	19.8

Wymagane jest zastosowanie zewnętrznego sterownika stałoprądowego LED.

Charakterystyka optyki - CRI > 80

at_p = 50 °C

CRI: R_a > 80

Wariant	Numer katalogowy	Połączenie	Prędkość światła (lm)	Prędkość światła (lm/W)	Prędkość światła (lm)	Prędkość światła (lm/W)	Prędkość światła (lm)	Prędkość światła (lm/W)	Prędkość światła (lm)	Prędkość światła (lm/W)	Prędkość światła (lm)	Prędkość światła (lm/W)	Prędkość światła (lm)	Prędkość światła (lm/W)		
LED Line SMD W2 Easy Gen. 2 - L28																
WU-M-700-TC/BC/STC-830	572672	572778	572779	WW	3000	500	180	830	175	995	173	1155	171	1645	166	830/349
WU-M-700-TC/BC/STC-840	572639	572637	572638	NW	4000	520	187	865	182	1035	180	1205	178	1710	173	840/349
WU-M-700-TC/BC/STC-850	572673	on request	572780	CW	5000	520	187	865	182	1035	180	1205	178	1710	173	850/349
WU-M-700-TC/BC/STC-865	572674	on request	572781	CW	6500	510	183	845	178	1010	176	1175	174	1675	169	865/349
LED Line SMD W2 Easy Gen. 2 - L56																
WU-M-701-TC/BC/STC-830	572675	572786	572787	WW	3000	1000	180	1660	175	1985	173	2310	171	3285	166	830/349
WU-M-701-TC/BC/STC-840	572644	572642	572643	NW	4000	1040	187	1725	182	2065	180	2405	178	3420	173	840/349
WU-M-701-TC/BC/STC-850	572676	on request	572813	CW	5000	1040	187	1725	182	2065	180	2405	178	3420	173	850/349
WU-M-701-TC/BC/STC-865	572677	572765	572789	CW	6500	1015	183	1690	178	2020	176	2355	174	3345	169	865/349

Wymagane jest zastosowanie zewnętrznego sterownika stałoprądowego LED.

Charakterystyka optyki - CRI>90

at_{lp} = 50 °C

CRI: R_a > 90

e ² 2 q z	Numer katalogowy Połączenie			b μ	ϕ ² 2 ϕ ² 6	p	Σ μ 66 S ² q ² s 66						b q z ⁵
	dół (TC)	górn (BC)	dół (STC)				130 mA lx	130 mA lx/W	350 mA lx	350 mA lx/W	500 mA lx	500 mA lx/W	

LED Line SMD W2 Easy Gen. 2 - L38

Model	Numer katalogowy	TC	BC	STC	WW	2700	405	146	670	541	795	139	920	136	1280	129	927/349
WU-M-700-TC/BC/STC-927	572750	on request	on request	on request	WW	2700	405	146	670	541	795	139	920	136	1280	129	927/349
WU-M-700-TC/BC/STC-930	572766	572782	572783	572783	WW	3000	405	146	670	541	795	139	920	136	1280	129	930/349
WU-M-700-TC/BC/STC-940	572767	572784	572785	572785	NW	4000	455	163	743	558	890	155	1025	152	1425	144	940/349
WU-M-700-TC/BC/STC-950	572768	on request	on request	on request	CW	5000	455	163	743	558	890	155	1025	152	1425	144	950/349
WU-M-700-TC/BC/STC-965	572769	on request	on request	on request	CW	6500	455	163	743	558	890	155	1025	152	1425	144	965/349

LED Line SMD W2 Easy Gen. 2 - L56

Model	Numer katalogowy	TC	BC	STC	WW	2700	815	146	1340	541	1595	139	1845	136	2560	129	927/349
WU-M-701-TC/BC/STC-927	572791	on request	on request	on request	WW	2700	815	146	1340	541	1595	139	1845	136	2560	129	927/349
WU-M-701-TC/BC/STC-930	572790	572791	572792	572792	WW	3000	815	146	1340	541	1595	139	1845	136	2560	129	930/349
WU-M-701-TC/BC/STC-940	572793	572794	572795	572795	NW	4000	905	163	1490	558	1775	155	2055	152	2850	144	940/349
WU-M-701-TC/BC/STC-950	572796	on request	on request	on request	CW	5000	905	163	1490	558	1775	155	2055	152	2850	144	950/349
WU-M-701-TC/BC/STC-965	572797	on request	on request	on request	CW	6500	905	163	1490	558	1775	155	2055	152	2850	144	965/349

A<<< b M s² 2 μ 4 s B<<< b M c² μ 2 μ 4 s B<<< b SDC<< b M S² 2 μ 4 s 5
 6 p μ² 68 Ø J A d² R q² 66 p μ² 68 q z 6 s² S² S μ c t S q² s d\$ =<0

Wymiary techniczne

TC = Połączenie górne
 BC = Połączenie dolne
 STC = Małe połączenie górne

WU-M-700-BC/TC

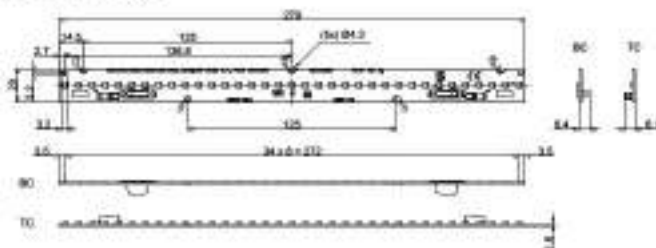

WU-M-700-STC

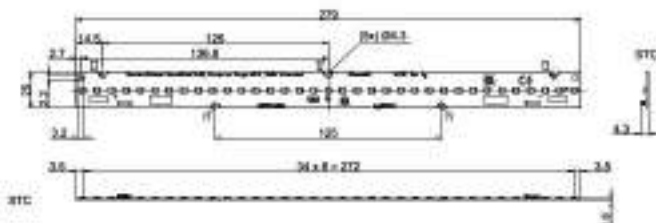

WU-M-701-BC/TC

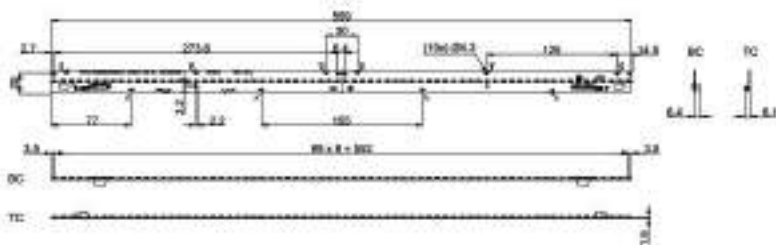

WU-M-701-STC

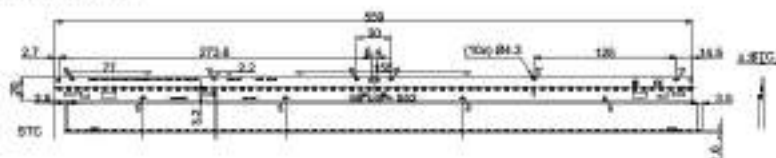

EasyLine DIP switch S

Cechy produktu

b 2z z 2 Øq

Funkcje

s Ø q śóś ct 2 ó é ó Ś² Ujh
 2 é µłł é ó é Ś q q ŚzŚq 2óśz
 śóś 4 é é ó é Ś µłł é5

Parametry elektryczne

e² Śóś Śóś éj >>< >B< r =<0
 T µ Śóś 2J C< D< Z
 w²óśz éśóś J<8C >8C
 w²óśz śóś J<8 =8C
 s ó Ś ó é é Øś é ŚJ N<8 C
 e² Śóś Ø q Ś 2 4j 2 :f D< r
 h é ó 2 Ś q dU Ś éśé Śq µ é:

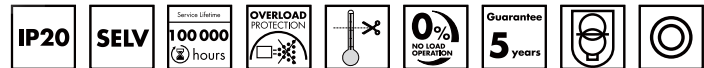

Parametry elektryczne

d ² : śóś	e ² 2 qčµ	Numer kat.	e ² Sóś C<Ø< Z r	h q Śóś R	h q óń R ;	h q śóś UT R 4 C05	e ² Sóś śóś é UT 4.5	pZU é Øś é Ś 0.4A< r.5	s q ² ś 2 : Øś é Ś 0.4A< r.5	p Ś S =<< Z 0
40	ECXe 700.671	187431	220-240	206-189	32 / 304	350-700	19-57	7	> 88	< 5
60	ECXe 1050.673	187436	220-240	305-279	28 / 352	700-1050	19-57	6	> 90	< 5
75	ECXe 1400.672	187432	220-240	383-351	30 / 360	700-1400	19-57	5	> 90	< 5

Wymiary

f Øq 2J b=<D
 U ł J =>F
 ó é z J F >
 s z J AB

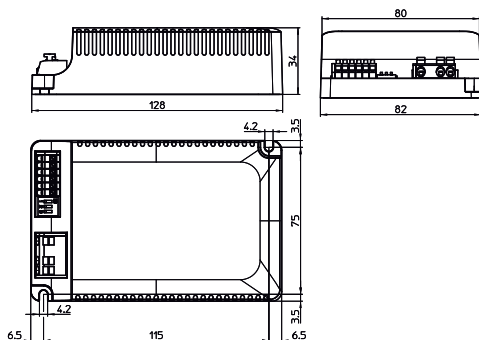

ComfortLine NFC S MidNight

Cechy produktu

b 2 z z 2 Ø q

Funkcje

s Ø q ś ó ś ć 2 ó Ś ć ě s e VV
h ł 2 2 ś Ğ q z ć 2 ó Ś ć ě s e VV
ó ś ś 2 ó ě z ó s d s e ś n
ó ś ś 2 ó ě z ó s T μ h r 2 ć
o 2 ś ś μ 4 d 5

Parametry elektryczne

e 2 Ś ó ś ś ó s ć j >>> > B < r RT
T μ ś ó ś C < D < Z
w 2 ó s z s z ć
s ć s ó s 48 e 8 h V; V ś V V 2 ć s ó j < B = B C
s ó s j < B = B C
s ó ś ś ó ć Ğ ó ś j N < 8 C
e 2 Ś ó s s ć 4 2 ś E < r 4 F E B D F B = << r
4 F E B D I B = >> r 4 F E B E < 5
d 2 z : 2 Ś ó s Ğ Ğ ó ć 4 f q p s = B < r 4 F E B E = B > D < r
4 F E B E > B A << r 4 F E B E A 5
h ć ó 2 ś q d U ś ć s ś ś q μ ć :

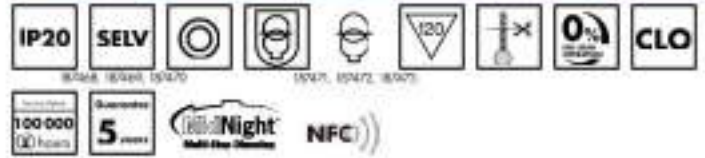

Parametry elektryczne

d 2 : ś ó s	e 2 2 q c μ	Numer kat.	w 2 z 2 ś ó s ć s r RT	Ś 2 p ć ć s r RT	h q ś ó s R	h q ó r R ;	h q ś ó s UT R 4 C O 5	q 2 ś ś ø Ğ ó ć R	e 2 Ś ó s ś ó s ć UT 4 5	p Z U ć 0 4 A < r 5	s q 2 s 2 : Ğ s ć s 0 4 A < r 5	p ś s = << Z 0
26.6	ECXe 1050.686	187468	176-305	160	35 / 200	110-1050	700	30-48	4	87	≤ 3	
40	ECXe 1050.687	187469	176-305	220	35 / 200	110-1050	700	28-60	3	89	≤ 3	
60	ECXe 1050.688	187470	176-305	320	35 / 200	110-1050	700	38-90	3	90	≤ 3	
80.5	ECXe 1050.689	187471	176-305	420	55 / 300	110-1050	700	35-120	3	91.5	≤ 3	
120	ECXe 1050.690	187472	176-305	600	60 / 300	110-1050	700	75-220	3	92	≤ 3	
165	ECXe 1050.691	187473	176-305	840	60 / 300	110-1050	700	115-270	3	93	≤ 3	

Wymiary

e ć 2 2 μ ł	p Ø q	U ł	o ć z	s z
187468	K72.2	132.5	77,4	40
187469				
187470				
187471				
187472				
187473	K75.2	171	101	41

K72.2

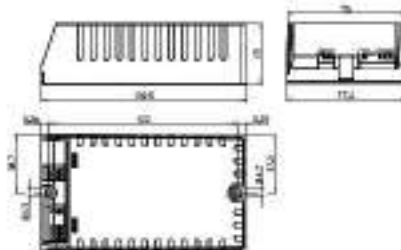

K75.2

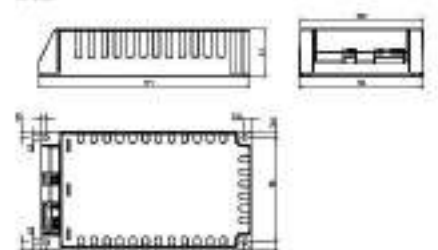

ComfortLine Prog S 1-10 V MidNight

Cechy produktu

b 2 z z 2 Ø q

Funkcje

s Ø 2 c Š q s óš dt c t 2 2 Š p Š c
h t 2 2 Š c Š c Š qoS
W z óš d Š e Š r
o 2 Š Š μ 4 f 5

Parametry elektryczne

e 2 Š óš Š óš c j =ED A<C r RT
T μ Š Š óš C< D< Z
w 2 óš z c
s c s óš 48e 8X Š <8 >8C
s s óš <8 =8C
óš Š Š <8 =8C
s ó Š ó c Š J N<8 D
e 2 Š óš Ø q Š 2 4 2 :Š FCr 4FEbDB5
d 2 z 2 μ c 2 Š óš Ø ó c 4f qp Š =D<r 4FEbDCŠ
>D<r 4FEbDDŠ A><r 4FEbDC5
h c ó 2 Š q dU Š c s Š Š q μ c:



Parametry elektryczne

d 2 : s óš	e 2 2 q c μ	Numer kat.	w 2 z c 2 Š óš c s óš dt 4C< D< Z 5r RT	h q Š óš R	h q ó r R ;	h q s óš UT R 4 CO5	q 2 Š Š Ø ó c R	e 2 Š óš s óš c UT 45	pZU c óš c Š 0 4A<r 5	s q 2 s 2 : óš c Š 0 4A<r 5	p Š Š =<< Z 0
40	ECXd 1050.682	187464	176-305	220	43 / 300	110-1050	700	24-60	3	89	≤3
80	ECXd 1050.683	187465	176-305	420	55 / 300	110-1050	700	35-120	3	91	≤3
120	ECXd 1050.684	187466	176-305	600	60 / 300	110-1050	700	75-220	3	92	≤3
165	ECXd 1050.685	187467	176-305	840	60 / 500	110-1050	700	115-270	3	93	≤3

Wymiary

e c z 2 μ t	p Ø q	U t	o c z	s z
187464	K72.2	132.5	77.4	40
187465				
187466				
187467	K75.2	171	101	41

K72.2

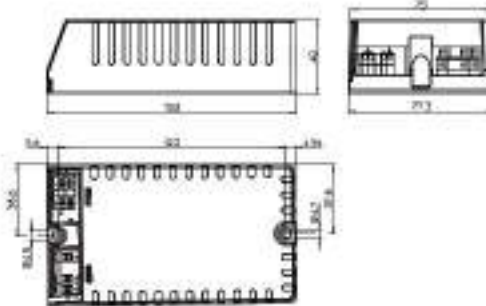

K75.2

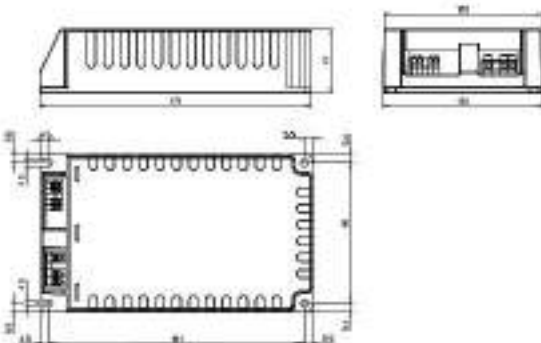

PrimeLine NFC S-MD DALI2 Dx

Cechy produktu

b 2z z 2 Øg

Funkcje

s Ø 2 c \$ q s ós ct c t 2 2 \$ e \$ c
 h t 2 2 \$ c \$ c \$ qoS
 W zóe d \$ e \$ rí
 o 2 \$ \$ µ 4 d 5

Parametry elektryczne

e 2 \$ ós \$ ós c j >>> >B<r RT
 T µ \$ \$ ós C< D< Z
 w 2 ós z c
 s c \$ ós 48e 8X \$ 5<8C >8C
 s \$ ós <8 =8C
 ós \$ \$ <8 =8C
 s ó \$ ó c ós c \$ J N<8 C
 e 2 \$ ós Ø q \$ 2 4 2 \$
 E<r 4FEAC>B=<<r 4FEAC>B=><r 4FEB<l 5
 d 2 z : e 2 \$ ós Ø ó c 4 f q p 5 =B<r 4FEACB
 >><r 4FEACCB>D<r 4FEB=<5
 T 2 ó r j = =8C



Parametry elektryczne

d 2 : s ós	e 2 2 qcp	Numer kat.	w 2 z c 2 \$ ós c \$ ós ct C< D< Z 5r RT	h q \$ ós R	h q ó r R ;	h q s ós UT R 4 CO5	q 2 \$ S ø Ø ó c R	e 2 S ós s ós c UT 4 5	pZU c ø s c s 0 φA<r 5	s q 2 s ? : ø s c s 0 φA<r 5	p \$ S =<< Z 0
26.6	ECXd 1050.639	187352	176-305	160	43 / 300	300-1050	700	20-38	4	88.5	≤ 3
40	ECXd 1050.640	187353	176-305	220	43 / 300	300-1050	700	28-57	3	90	≤ 3
60	ECXd 1050.659	187409	176-305	320	43 / 300	300-1050	700	30-86	3	90	≤ 3
80.5	ECXd 1050.641	187354	176-305	420	55 / 300	300-1050	700	35-115	3	91.5	≤ 3
120	ECXd 1050.642	187355	176-305	600	60 / 300	300-1050	700	75-172	3	93	≤ 3
165	ECXd 1050.660	187410	176-305	840	60 / 500	300-1050	700	115-236	3	94	≤ 3

Wymiary

e c z 2 µ t	p Øg	U t	ó c z	s z
187352	K72.2	132.5	77,4	40
187353				
187354				
187355				
187409				
187410	K75.2	171	101	41

K72.2

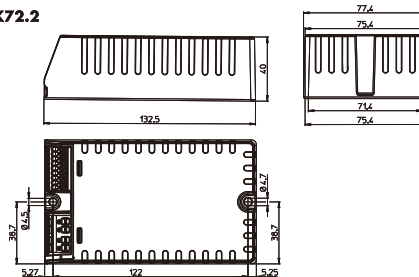

K75.2

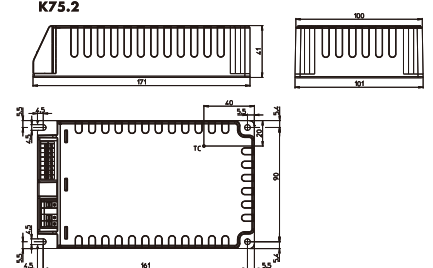

ComfortLine Prog S 100 V

1-10 V IP

Cechy produktu

b 2z z 2 Øq

Funkcje

s Ø 2 é Š q s óš ét é t 2 2 Š e Š é
 h t 2 2 Š é Š é š qoS
 W zóš d š e š n
 o 2 Š é Š μ 4 d 5

Parametry elektryczne

e 2 Š óš Š óš é j <<< > EE r =<0
 T š Š óš 2 J C<; D< Z
 s Š é é q ó é Š é j Š é é j
 A = 4s X = E Š q t J A << é j > =
 4s X = E Š = <r Š t 2 2 Š j > <8AC
 s ó Š ó é Š óš é Š J N <8 E
 4s X >> Š q t J A <<
 e 2 Š óš Ø q Š 2 4 2 :5
 ; d 2 z : 2 Š óš Ø ó é 4 f q p Š
 h é ó 2 Š é Š é é š q
 d U š Š q μ é:

Ref. No.	Umax(V)	UOUT(V)
187082	120	-
187083	-	170
187084	-	240
187085	-	300
187086	-	380
187087	-	480



IP67

187082

SELV

187082

187082

187083, 187084, 187085, 187086, 187087

110

187084, 187087

OVERLOAD PROTECTION

MidNight
Multi-Step Dimming

0%
NO LOAD OPERATION

CLO

Service Lifetime
100000
hours

Guarantee
5
years

1-10V

Parametry elektryczne

d 2 : š óš	e 2 2 q c μ	Numer kat.	e 2 Š óš C<Ø< Z r =<0	h q š óš R	h q ó n R ;	h q š óš UT R 4 CO5	q 2 Š é Š é Ø ó é R	e 2 Š óš š óš é UT 4.5	sz U é 0 4A< r 5	s q 2 s 2 : 0š é é š 0 4A< r 5	p é Š =<< Z 0
75	ECXd 1050.446	187082	100-277	870-310	63 / 200	100-1050	700	40-108	7	90	< 10
105	ECXd 1050.447	187083	100-277	1220-430	52 / 276	100-1050	700	65-157	3	93.5	< 10
150	ECXd 1050.448	187084	100-277	1700-600	68 / 308	100-1050	700	100-214	3	94.5	< 10
200	ECXd 1050.449	187085	100-277	2300-820	86 / 336	100-1050	700	130-286	4	93.5	< 5
240	ECXd 1050.450	187086	100-277	2700-970	59 / 500	100-1050	700	115-349	4	94.5	< 5
320	ECXd 1100.451	187087	100-277	3650-1300	76 / 600	110-1100	700	220-457	7	93.5	< 10

Wymiary

e é é 2 μ t	p Ø q	U t	ó é z	s z
187082	M87.1	128.6	68	37
187083	M88.1	153.6	68	37
187084	M89.1	173.6	68	37
187085	M90.1	193.6	68	39
187086	M91.1	208.6	68	39
187087	M92.1	231	98	42

M87.1

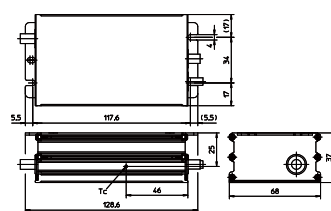

M88.1

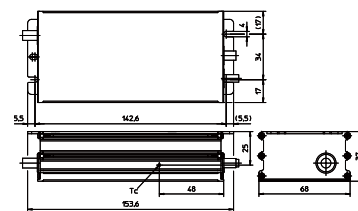

M89.1

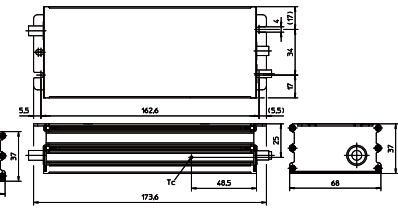

M90.1

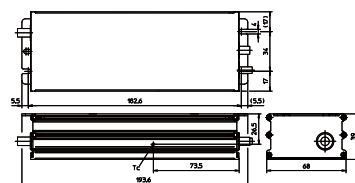

M91.1

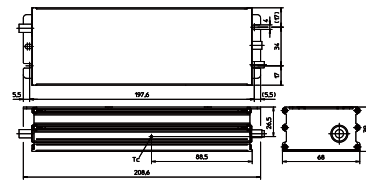

M92.1

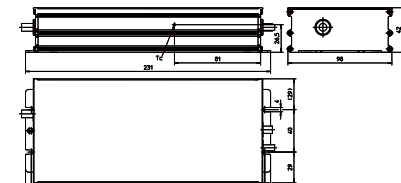

ComfortLine Prog S-1-10V 100V IP 40W

Cechy produktu

b 2z z 2 Øq

Funkcje

s Ø 2 c Š q s óŠ cł c t 2 2 Š e Š c
h t 2 2 Š c Š c Š qoS
W zóš d Š e Š n
o 2 Š Š μ 4 d 5

Parametry elektryczne

e 2 Š óŠ Š óŠ cł = << > EE r = < 0
T μŠ Š óŠ 2 J C < ; D < Z
s Š 2 c c q ó c Š cł Š cł
A = 4s X = E Š q t J A << cł > =
4s X = E Š = = < r Š t 2 2 Š J > < 8 AC
4s X >> Š q t J > C <
s ó Š ó c ØŠ c Š J N < 8 D
e 2 Š óŠ Ø q Š 2 4 2 : Š F < r
h c ó 2 Š q d V U Š c Š c Š q μ c :

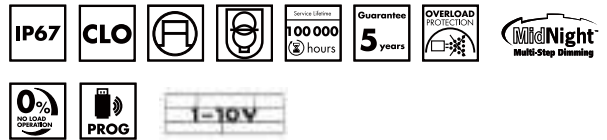

Parametry elektryczne

d 2 :	e 2 2	Numer kat.	e 2 Š óŠ C < Ø < Z r = < 0	h q Š óŠ R	h q ón R ;	h q s óŠ UT R 4 C05	q 2 Š Š Ø ó c R	e 2 Š óŠ s óŠ c UT 4.5	p Z U c ØŠ c Š 0 4-A < r 5	s q 2 Š 2 : ØŠ c Š 0 4-A < r 5	p Š Š = << Z 0
B <	V T i q = C < : C F >	187251	= << 9 EE	B I E 9 F >	A < ; = < F	= << 9 < C <	E <<	> F Ø E	C	F : C C	L E

Wymiary

e c z 2 2 μ t	p Ø q	U t	o c z	s z
187251	M96	117	67	37

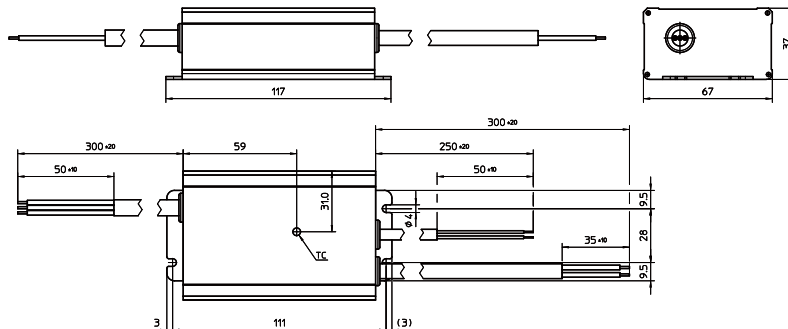

Wymiary

e c	p	U t	o c z	s z
$\varnothing^2 \mu t$	$\varnothing q$			
187088	M87	128,6	68	37
187089	M88	153,6	68	37
187090	M89	173,6	68	37
187091	M90	193,6	68	39
187092	M91	208,6	68	39
187093	M92	231	98	42

Rysunki i zdjęcia produktów

M87

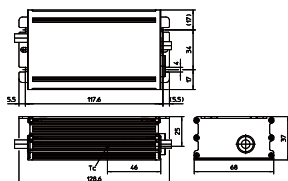

M87 - 187088

M88

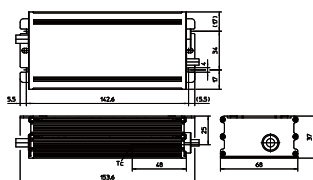

M88 - 187089

M89

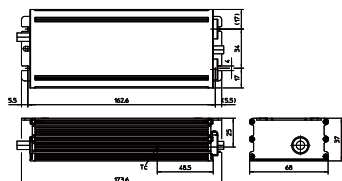

M89 - 187090

M90

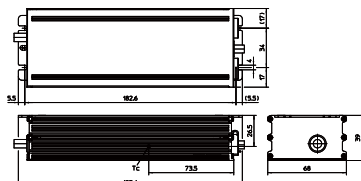

M90 - 187091

M91

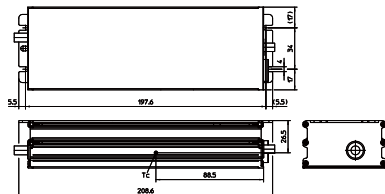

M91 - 187092

M92

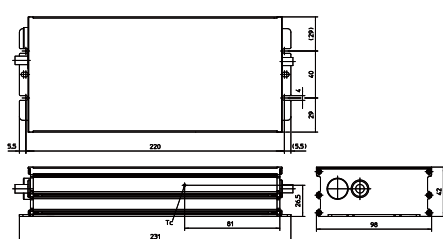

M92 - 187093

EasyLine DIP switch S-100 V IP

Cechy produktu

b 2 z z 2 Øq

Funkcje

d µs Ø g óóó óóó óóó
óóó óóó Ujh

Parametry elektryczne

e 2 óóóó óóóó óóóó óóóó óóóó
T µs óóóó óóóó óóóó óóóó
s óóóó óóóó óóóó óóóó óóóó
A = R s X = E B g t J A << óóóó óóóó óóóó
R s X = E B g t J A <<
s óóóó óóóó óóóó óóóó óóóó
e 2 óóóó óóóó óóóó óóóó óóóó
h óóóó óóóó óóóó óóóó óóóó
óóóó óóóó µ óóóó

Ref. No.	U _{max.} (V)
187242	60
187243	66
187244	65

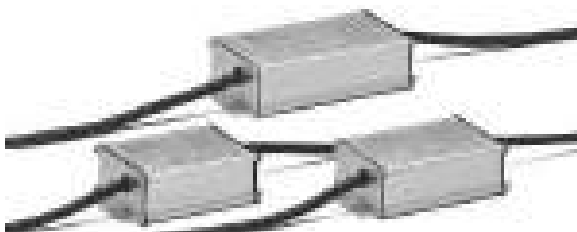

Parametry elektryczne

d 2 : óóóó	e 2 2 g óóó	Numer kat.	e 2 óóóó C < D < Z r = < 0	h g óóóó R	h g óóóó R ;	h g óóóó UT R 4 CO5	q 2 óóóó óóóó óóóó R	e 2 óóóó óóóó óóóó UT 4.5	p Z U óóóó óóóó óóóó 0 óóóó < r 5	s q 2 óóóó óóóó : óóóó óóóó 0 óóóó < r 5	p óóóó óóóó < Z 0
26	ECXe 700.573	187242	100-240	370-130	25 / 136	350-700	500	20-52	8	87	< 10
40	ECXe 1050.574	187243	100-240	580-190	41 / 200	350-1050	700	20-57	8	88	< 10
60	ECXe 1400.575	187244	100-240	820-280	45 / 225	900-1400	1050	20-57	9	90.5	< 10

Wymiary

e óóóó z 2 µ t	p Øq	U t	óóóó z	s z
187242	M94	108	64	32
187243	M97	116	64	32
187244	M95	140	64	32

M94

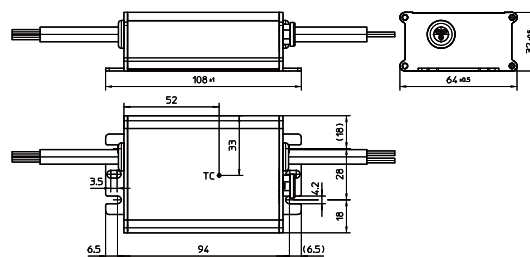

M97

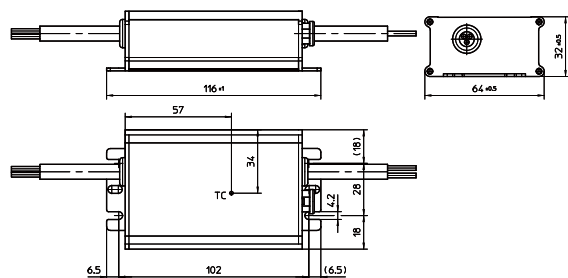

M95

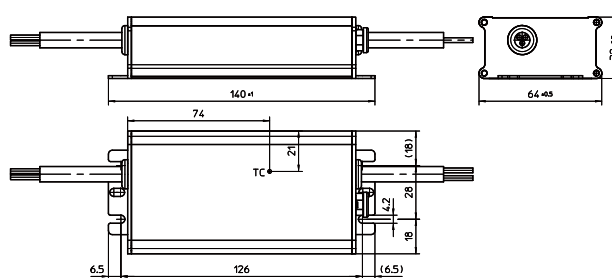

Charakterystyka optyki

at_l = 60 °C, CRI** ≥ 70

e ² / q z	Numer katalogowy	b μ / Ś ²	α : / Ø ² / b	350 mA		500 mA		700 mA		1050 mA		1400 mA	
				η _p / %	η _p / W	η _p / %	η _p / W	η _p / %	η _p / W	η _p / %	η _p / W	η _p / %	η _p / W
WU-M-630-SA/4-722	573280	warm white	2200	700	184	980	176	1330	168	1915	155	2455	144
WU-M-630-SA/4-730	573125	warm white	3000	795	208	1105	199	1505	189	2160	175	2770	163
WU-M-630-SA/4-740	573126	neutral white	4000	825	217	1150	208	1565	197	2255	182	2890	170
WU-M-630-SA/4-750	573219	cool white	5000	815	214	1135	205	1545	195	2225	180	2850	168
WU-M-630-SA/8-722	573215	warm white	2200	1405	184	1955	176	2660	168	3830	155	4910	144
WU-M-630-SA/8-727	573128	warm white	2700	1540	202	2145	193	2920	184	4200	170	5385	158
WU-M-630-SA/8-730	573129	warm white	3000	1585	208	2210	199	3005	189	4320	175	5545	163
WU-M-630-SA/8-740	573130	neutral white	4000	1655	217	2305	208	3135	197	4510	182	5785	170
WU-M-630-SA/8-750	573220	cool white	5000	1630	214	2270	205	3090	195	4445	180	5705	168
WU-M-630-SA/12-722	573216	warm white	2200	2105	184	2935	176	3995	168	5745	155	7365	144
WU-M-630-SA/12-727	573132	warm white	2700	2310	202	3215	193	4380	184	6300	170	8080	158
WU-M-630-SA/12-730	573133	warm white	3000	2380	208	3310	199	4510	189	6485	175	8315	163
WU-M-630-SA/12-740	573134	neutral white	4000	2480	217	3455	208	4700	197	6760	182	8675	170
WU-M-630-SA/12-750	573221	cool white	5000	2445	214	3405	205	4635	195	6670	180	8555	168
WU-M-630-SA/16-722	573217	warm white	2200	2810	184	3910	176	5325	168	7655	155	9820	144
WU-M-630-SA/16-727	573136	warm white	2700	3080	202	4290	193	5840	184	8400	170	10775	158
WU-M-630-SA/16-730	573137	warm white	3000	3170	208	4415	199	6010	189	8645	175	11090	163
WU-M-630-SA/16-740	573138	neutral white	4000	3310	217	4605	208	6270	197	9015	182	11565	170
WU-M-630-SA/16-750	573222	cool white	5000	3265	214	4540	205	6185	195	8890	180	11405	168

wc łμ q² / óc q z6ś q 8 / c² óś² / Śc q / Ś / c² ó c :
 s² / óśc / Ś² / c q / Ś q² s q z² q / Ś / ó / Ś² / c² / z² qct / q z 8z / c / t / Ś / Ś q / ó / c² / c :
 ó p μ c² / óś / Ś / Ś / Ś μ ct / J E0 / ó ó p μ c² / óś / Ś / T k j >

Charakterystyka optyki

at_l = 60 °C, CRI** ≥ 80

e ² / q z	Numer katalogowy	b μ / Ś ²	α : / Ø ² / b	350 mA		500 mA		700 mA		1050 mA		1400 mA	
				η _p / %	η _p / W	η _p / %	η _p / W	η _p / %	η _p / W	η _p / %	η _p / W	η _p / %	η _p / W
WU-M-630-SA/4-830	on request	warm white	3000	700	184	980	176	1330	168	1915	155	2455	144
WU-M-630-SA/4-840	573127	neutral white	4000	750	196	1040	188	1415	178	2040	165	2615	154
WU-M-630-SA/8-830	on request	warm white	3000	1405	184	1955	176	2660	168	3830	155	4910	144
WU-M-630-SA/8-840	573131	neutral white	4000	1495	196	2080	188	2835	178	4075	165	5230	154
WU-M-630-SA/12-830	on request	warm white	3000	2105	184	2935	176	3995	168	5745	155	7365	144
WU-M-630-SA/12-840	573135	neutral white	4000	2245	196	3125	188	4250	178	6115	165	7840	154
WU-M-630-SA/16-830	on request	warm white	3000	2810	184	3910	176	5325	168	7655	155	9820	144
WU-M-630-SA/16-840	573139	neutral white	4000	2990	196	4165	188	5670	178	8150	165	10455	154

wc łμ q² / óc q z6ś q 8 / c² óś² / Śc q / Ś / c² ó c :
 s² / óśc / Ś² / c q / Ś q² s q z² q / Ś / ó / Ś² / c² / z² qct / q z 8z / c / t / Ś / Ś q / ó / c² / c :
 ó p μ c² / óś / Ś / Ś / Ś μ ct / J E0 / ó ó p μ c² / óś / Ś / T k j >

WU-M-630-SA/8

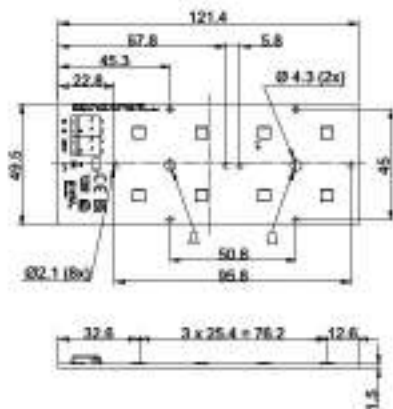

WU-M-630-SA/12

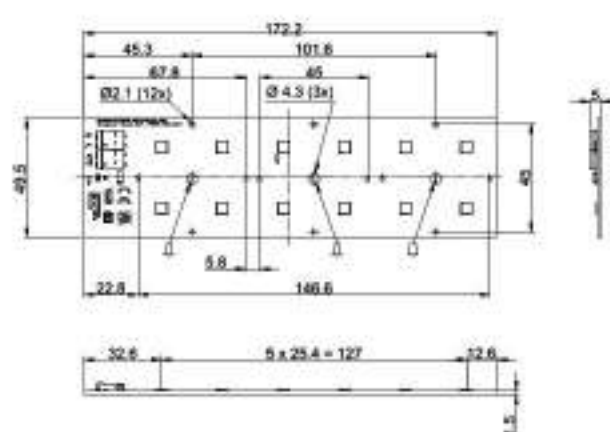

s / zś / >R / c² / Ś² / Ś q j / zś / s / zś / BBA / c² / Ś² / Ś q j / zś / HT S :

2x2 Streetlight Compact Optics for SMD W5 - 5050

Dane techniczne dotyczące optyki

$s = \frac{2}{\sqrt{2}} \cdot \frac{d}{R}$ $q = \frac{1}{D \cdot O}$
 $d = \frac{2}{\sqrt{2}} \cdot J \cdot h \cdot d \cdot R$
 $s = \frac{2}{\sqrt{2}} \cdot \frac{d}{R}$ $\epsilon = \frac{2}{\sqrt{2}} \cdot C < C <$
 $w^2 \cdot z \cdot \epsilon \cdot \epsilon^2$ $2 \cdot \delta \cdot h \cdot d \cdot R \cdot J \cdot q \cdot B < T \cdot q \cdot F < T$
 $w^2 \cdot z \cdot \epsilon \cdot \epsilon^2$ $2 \cdot \delta \cdot h \cdot d \cdot R \cdot Z \cdot J \cdot q \cdot B < T \cdot q \cdot l < T$
 $f = \frac{2}{\sqrt{2}} \cdot \frac{d}{R}$ $\epsilon = \frac{2}{\sqrt{2}} \cdot \frac{d}{R} \cdot A; d \cdot B$
 $d = \frac{2}{\sqrt{2}} \cdot \frac{d}{R} \cdot \mu$ $\epsilon = \frac{2}{\sqrt{2}} \cdot \frac{d}{R} \cdot A \cdot J < C \cdot e \cdot K$
 $d \cdot B \cdot J = B \cdot e$

k	§ 2	p	Numer kat.	d 2 c §	Vg. z 0	s 2 l 2	d q z 2 §
M5	95535	570137	PMMA HT	93	11.4	544	
M3M	95536	569966	PMMA HT	92	9.6	544	
P2M	95537	569967	PMMA HT	93	11.6	544	
A5	95538	569968	PMMA HT	94	8.1	544	
T3	95521	573244	PMMA	93	8.5	560	
DWC	95522	573245	PMMA	93	11.4	560	
CAT	95534	573282	PMMA	96	6.7	560	
FA60	95509	573165	PMMA	93	13.2	560	



Krzywe rozsyłu światła

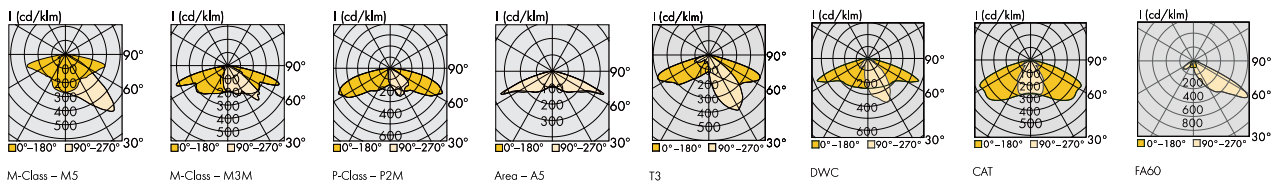

M-Class - M5 M-Class - M3M P-Class - P2M Area - A5 T3 DWC CAT FA60

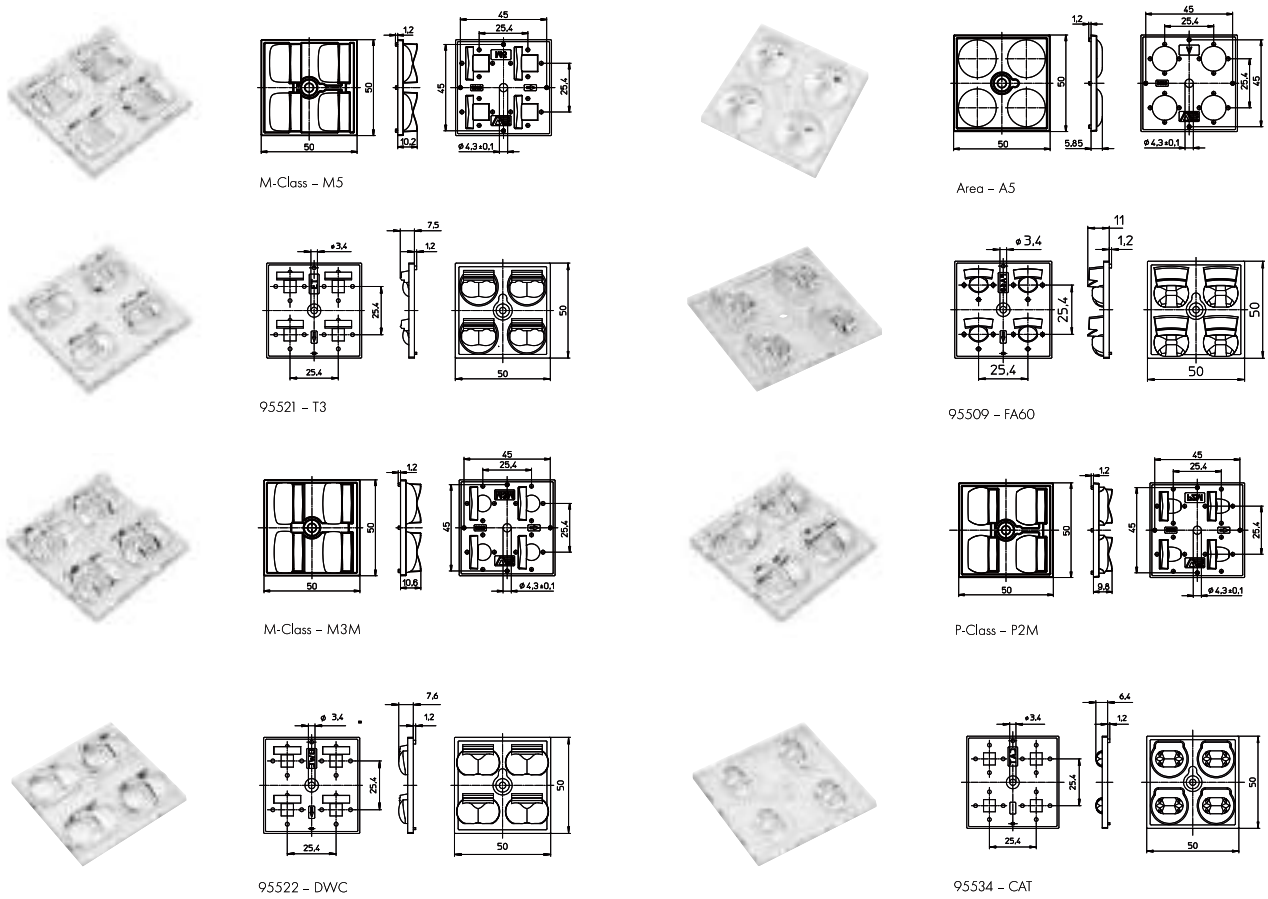

M-Class - M5

Area - A5

95521 - T3

95509 - FA60

M-Class - M3M

P-Class - P2M

95522 - DWC

95534 - CAT

SPD SP3/277/10K IP67 INLINE

Cechy produktu

w² Ø Śó c Ś² Ś² µ c Ś² µ c Ś² µ c
 z² Ś² µ c Ś² µ c Ś² µ c]
 s c Ś ó c µ Ś c
 o Ś ó rí J]hDE
 U ó c Ś c c t c t 8ohU µ c t c
 h c q Z<Cke MAX =&



Dane techniczne

Dane techniczne		142815
e ² Śó c Ś ² µ c	U _n	100-277V +/-10%
d ² z ² µ c ² Śó c Ø ó c	U _c	350 Vac
T µ Ś ² µ c	f _n	50-60 Hz
p Śó c		TN
d ² z ² µ c q Ø ó c Ś	I _L	5 A
e ² Śó c	U	10.000 V
d ² z ² µ c q µ c ² Ś	A	10.000
h q µ c ² Ś ² µ c t	A	5.000
h Ś ó rí µ c Śó c c c c	U (L-N)	< 1.500 V
h Ś ó rí µ c Śó c c c cV	U (L-PE)	< 1.500 V
o Ś ó rí		IP67
U ó µ c ² c c ² µ c Ø q	I _c	-35...85 °C
f q ó Ś		
s ó Ś c Ś		Internal
S c Śó c c		
s z ² Ś q Ś ² Ś 4VU5		Yes
p µ c Śó c Ś		T2 + T3
wł q		EN 61643-11:2012+A11:2018
s µ c ²	g	122

Rysunek

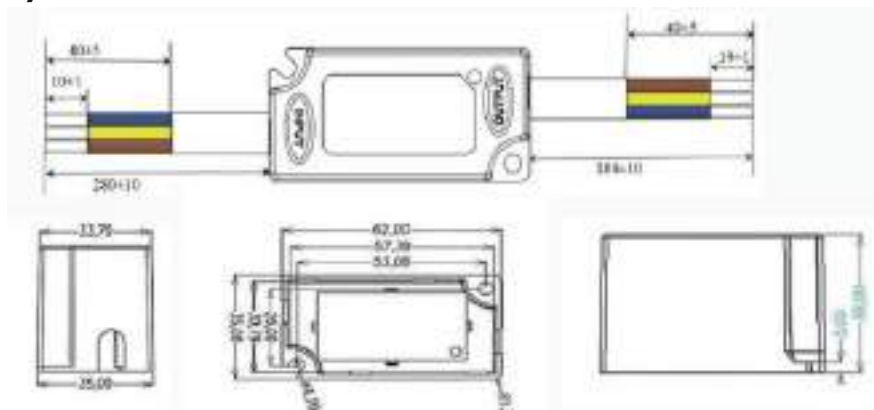

EasyLine 12 V C-L

Cechy produktu

$U_{in} = 220-240V$
 $U_{out} = 12V$
 $I_{max} = 0,5A$
 $P_{max} = 5W$

Parametry elektryczne

$\eta = 80-90\%$
 $T_{amb} = 25^{\circ}C$
 $\theta_{JA} = 20^{\circ}C/W$
 $T_{max} = 100^{\circ}C$
 $f_{sw} = 20kHz$

Cechy bezpieczeństwa

SELV, IP20, 30000h, 5 years warranty, 0% no-load operation, Overload protection.

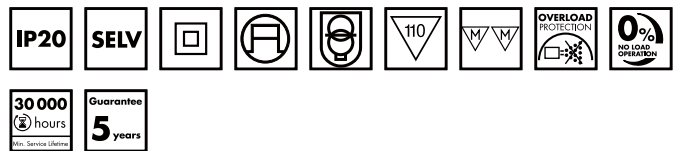

Parametry elektryczne

Wzrost	Wzrost	Numer kat.	Wzrost	Wzrost	Wzrost	Wzrost	Wzrost	Wzrost	Wzrost	
20	EDXe 120/12.095	187460	220-240	270-190	186 / 11	0-1670	12	n.a.	> 86	≤ 5
60	EDXe 160/12.096	187461	220-240	330-290	27 / 450	0-5000	12	< 11	> 88	≤ 5
75	EDXe 175/12.097	187462	220-240	390-355	29 / 250	0-6250	12	< 8	> 90	≤ 5
100	EDXe 1100/12.098	187463	220-240	550-430	38 / 350	0-8300	12	< 7	> 90	≤ 5

Wymiary

$f_{max} = 20kHz$
 $e_{max} = 100^{\circ}C$
 $U_{in} = 220-240V$
 $U_{out} = 12V$
 $I_{max} = 0,5A$

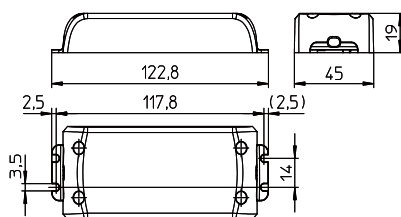

$f_{max} = 20kHz$
 $e_{max} = 100^{\circ}C$
 $U_{in} = 220-240V$
 $U_{out} = 12V$
 $I_{max} = 0,5A$

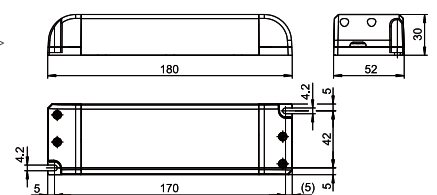

$f_{max} = 20kHz$
 $e_{max} = 100^{\circ}C$
 $U_{in} = 220-240V$
 $U_{out} = 12V$
 $I_{max} = 0,5A$

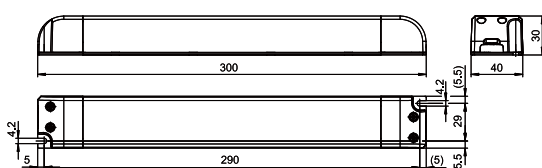

EasyLine 24 V C-L Gen.2

Cechy produktu

$b^2 z^2 \varnothing q$
 $U^2 \dots$
 $q A < 8D < 8EC8 = > < S = F < s$

Parametry elektryczne

$e^2 S \dots$
 $T \dots$
 $w^2 \dots$
 $s \dots$

Cechy bezpieczeństwa

$f \dots$
 $V \dots$
 $w^2 \dots$
 $o \dots$
 $b \dots$
 $o \dots$
 $h \dots$

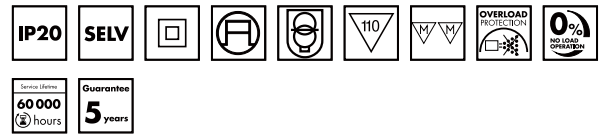

Parametry elektryczne

d ² :	e ² z	Numer kat.	e ² S	h q	h q	h q	e ² S	pZU	s q	p S
s	g		C < D < Z	R	R ;	R 4 C05	UT 4 C05	0.4A < 1.5	0.4A < 1.5	= < < Z
30	EDXe 130/24.090	187000	220-240	160-145	16 / 264	0-1250	24	8	88	≤ 3
60	EDXe 160/24.091	187001	220-240	310-280	27 / 300	0-2500	24	8	89	≤ 3
75	EDXe 175/24.092	187002	220-240	390-355	29 / 250	0-3125	24	7	90	≤ 3
120	EDXe 1120/24.093	187003	220-240	602-530	38/365	0-5000	24	6	93	≤ 3
180	EDXe 1180/24.094	187004	220-240	900-800	28 / 137	0-7500	24	6	94	≤ 3

Maksymalne wartości znamionowe

h e z o c s z z 2 mu ori z os 2 S ori c z q S g z oc S os mu S o c s c s :

Numer kat.	wz c c e 2 o c s		wz c s os o c s		wz c c e 2		wz c s t os		d z 2 mu 2 c e 2 z	o s
	°C min.	°C max.	% min.	% max.	°C min.	°C max.	% min.	% max.		
187000	-20	+45	20	90	-40	+80	10	90	+80	IP20
187001	-20	+45							+85	
187002	-20	+45							+85	
187003	-20	+45							+85	
187004	-20	+50							+85	

ComfortLine 24 V L DALI2

Cechy produktu

$b = 2z$ $z = 2 \varnothing q$
 $U = 2 \xi = 2 \mu \xi \omega \acute{o} r$ $\acute{c} q \acute{S} \acute{S} q$ $2 z \acute{c} \acute{S} \acute{o} q$
 $BC8F < 8 = C < \acute{S} > C < s$

Parametry elektryczne

$e = 2 \acute{S} \acute{o} \acute{S} \acute{S} \acute{o} \acute{S} \acute{c} j > > < > B < r = < 0$
 $T = \mu \acute{S} \acute{S} \acute{o} \acute{S} 2 j C < D < Z$
 $w = 2 \acute{o} \acute{S} \acute{S} \acute{z} \acute{c} j < 8 C = 8 C = > 8 C$ $q j \acute{f} \acute{o} \acute{S} \acute{o} \acute{S} \acute{c} \acute{S}$
 $> C < s$
 $s \acute{o} \acute{S} \acute{o} \acute{c} \acute{c} \acute{o} \acute{S} \acute{c} \acute{S} j N < 8 C T$
 $o r d j L < 8 B$
 $h a d j L =$

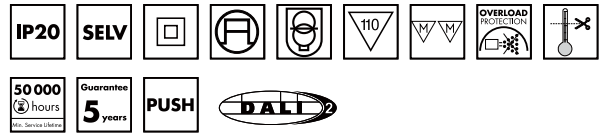

Parametry elektryczne

d^2 : śóś	e^2 2 qćµ	Numer kat.	e^2 Sóś C<D<Z	h q śóś R	h q ó r R ;	h q śóś UT R 4 C05	e^2 Sóś śóś c UT 4 C05	pZU c óś c ś 0.4A<r.5	s q 2 s 2 : óś c ś 0.4A<r.5	p ś S =<< Z 0
45	EDXd 145/24.085	187361	220-240	236-217	18 / 240	0-1875	24	< 8	> 86	≤ 1
80	EDXd 180/24.086	187362	220-240	411-377	37 / 264	0-3333	24	< 7	> 88	≤ 1
150	EDXd 1150/24.087	187363	220-240	741-681	45 / 432	0-6250	24	< 7	> 92	≤ 1
250	EDXd 1250/24.088	187430	220-240	1240-1139	47/640	0-10416	24	< 4	> 93	≤ 1

Wymiary

$f \varnothing q = 2 j b = < =$
 $e \acute{c} e j = FEAD =$
 $U \acute{t} j = FE$
 $o \acute{c} z j BC$
 $s z j A =$

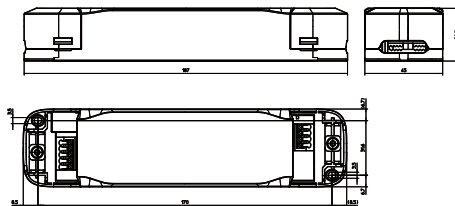

$f \varnothing q = 2 j b = < >$
 $e \acute{c} e j = FEAD > 8 = FEADA$
 $U \acute{t} j > <$
 $o \acute{c} z j BC$
 $s z j A =$

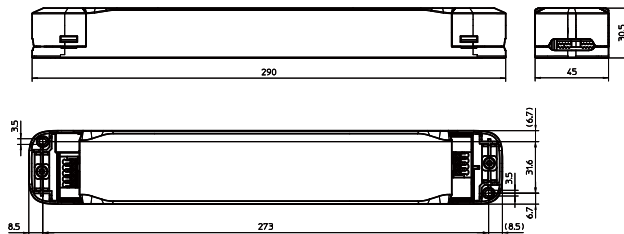

$f \varnothing q = 2 j b = < C$
 $e \acute{c} e j = FEBA <$
 $U \acute{t} j BA =$
 $o \acute{c} z j BC$
 $s z j A =$

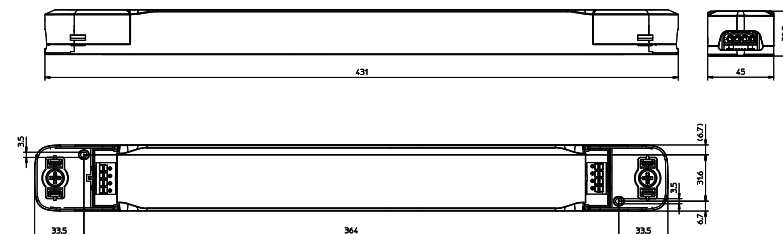

ComfortLine 24 V DALI2 IP67

Cechy produktu

b² z² Øq² hDE
U² z² z² c² s² BCs 8F<s 8=C<s

Parametry elektryczne

e² s² s² c² j >>> >B<r =<0
T j² s² s² j C< D< Z
s² s² s² c² c² s² j N<8 C
ordJ L <B
h adJ L =

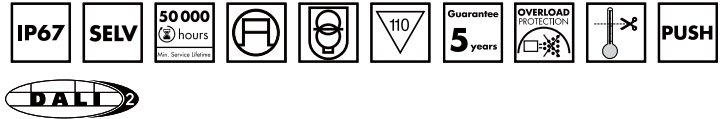

Parametry elektryczne

d ² : s ² s ²	e ² z ² q ² c ² j	Numer kat.	e ² s ² s ² C<D< Z r	h q s ² s ² R	h q óñ R ;	h q s ² s ² UT R 4 C05	e ² s ² s ² s ² c ² c ² UT 4 C05	pZU c ² s ² c ² s ² 0.4A<r 5	s ² q ² s ² z ² : s ² c ² s ² 0.4A<r 5	p s ² s ² =<< Z 0
45	EDXd 145/24.099	187507	220-240	236-218	20 / 261	0-1881	24	< 12	> 88	≤ 1
80	EDXd 180/24.100	187508	220-240	409-375	32 / 256	0-3334	24	< 9	> 89	≤ 1
150	EDXd 1150/24.101	187509	220-240	762-218	48 / 406	0-6253	24	< 6	> 90	≤ 1

Wymiary

f Øq ?J b=<>
e c² j =FEC<E
U t J =DE
o c z J C<
s z J A<:C

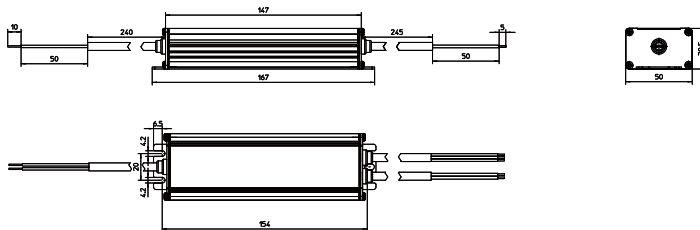

f Øq ?J b=<A
e c² j =FEC<F
U t J ><E
o c z J C<
s z J A<:C

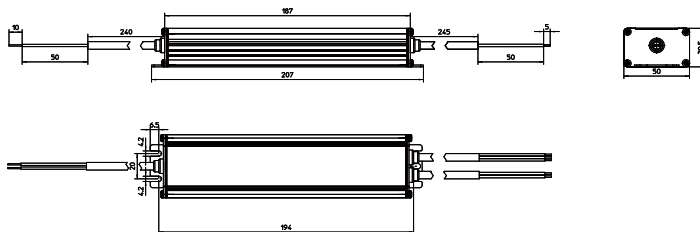

f Øq ?J b=<B
e c² j =FEC<l
U t J >D>
o c z J C<
s z J A<:C

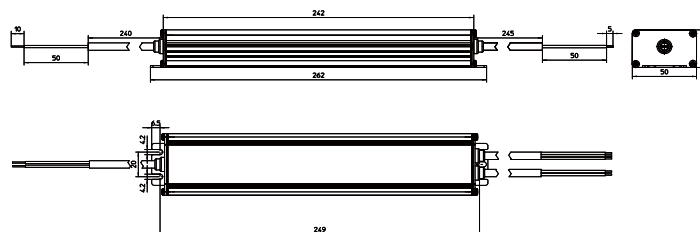

WE THINK LIGHT FOR YOU

Vossloh-Schwabe Deutschland GmbH

Stuttgarter Straße 61/1 · 73614 Schorndorf
Phone +49 (0)7181 8002-0

www.vossloh-schwabe.com

All rights reserved © Vossloh-Schwabe
Photos: stock.adobe.com
Technical changes are made
without notification
VS product news EN 10/2025